



OLDSMOBILE





Oh-h-h ! those '56  
**OLDSMOBILES !**

Close your eyes a moment . . . now, look again at Oldsmobile for '56! Sparkling Starfire styling . . . from smartly fashioned airfoil grille . . . through sweeping, blending body lines . . . back to flair-away fenders! Again Oldsmobile flashes ahead—with the smoothly powerful new Rocket T-350 Engine and powerfully smooth new Jetaway Hydra-Matic Drive!



Sleek, sweeping lines . . . breath-taking colors and new fabric combinations give this success-laden Super '88' 4-Door Holiday Sedan a dashing new look that's all its own . . . without pillars or posts to mar the view!



**SUPER '88' HOLIDAY SEDAN**



SUPER '88' HOLIDAY COUPÉ

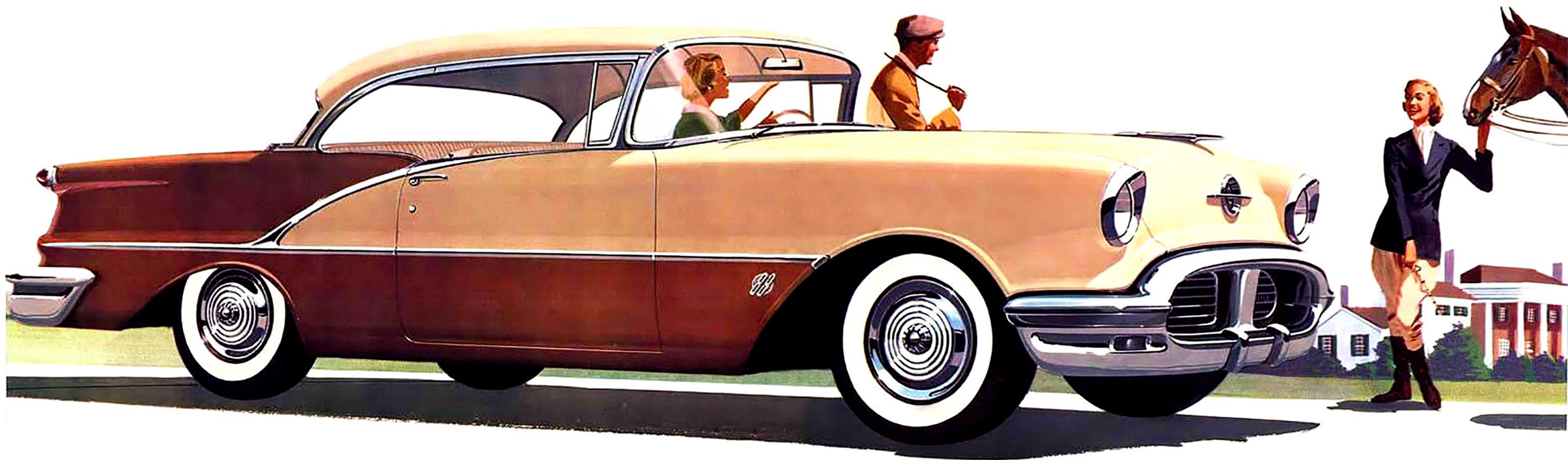

**Aglow with glamor**

**—and a power personality**

**to match!**



Off to the hunt . . . the hills . . . or the highway . . . this handsome hardtop has a carefree spirit of its own . . . with Starfire styling and rocketing power that swings you along . . . into the "smart set" for '56! And the going is always powerfully smooth as new Jetaway Hydra-Matic teams with the mighty Rocket T-350. Join the circle of new Rocket owners and experience the most wonderful motoring in the world!



Step in . . . to a new world of richly fashioned fabrics and styled-to-be-admired interior appointments.



SUPER '88" 4-DOOR SEDAN



A masterpiece of interior harmony made up of new fabrics, with fresh pattern ideas, rich carpeting . . . gleaming trim and appointments!



Hold on now! For here are power and glory . . . matched and fused for action . . . from the brilliance and beauty of Starfire styling to the powerful feel of its Rocket T-350 Engine. Here is a combination of stunning beauty and surging action that you find only in Oldsmobile. And all the modern features plus new Jetaway Hydra-Matic are always at your command. This one is for you!



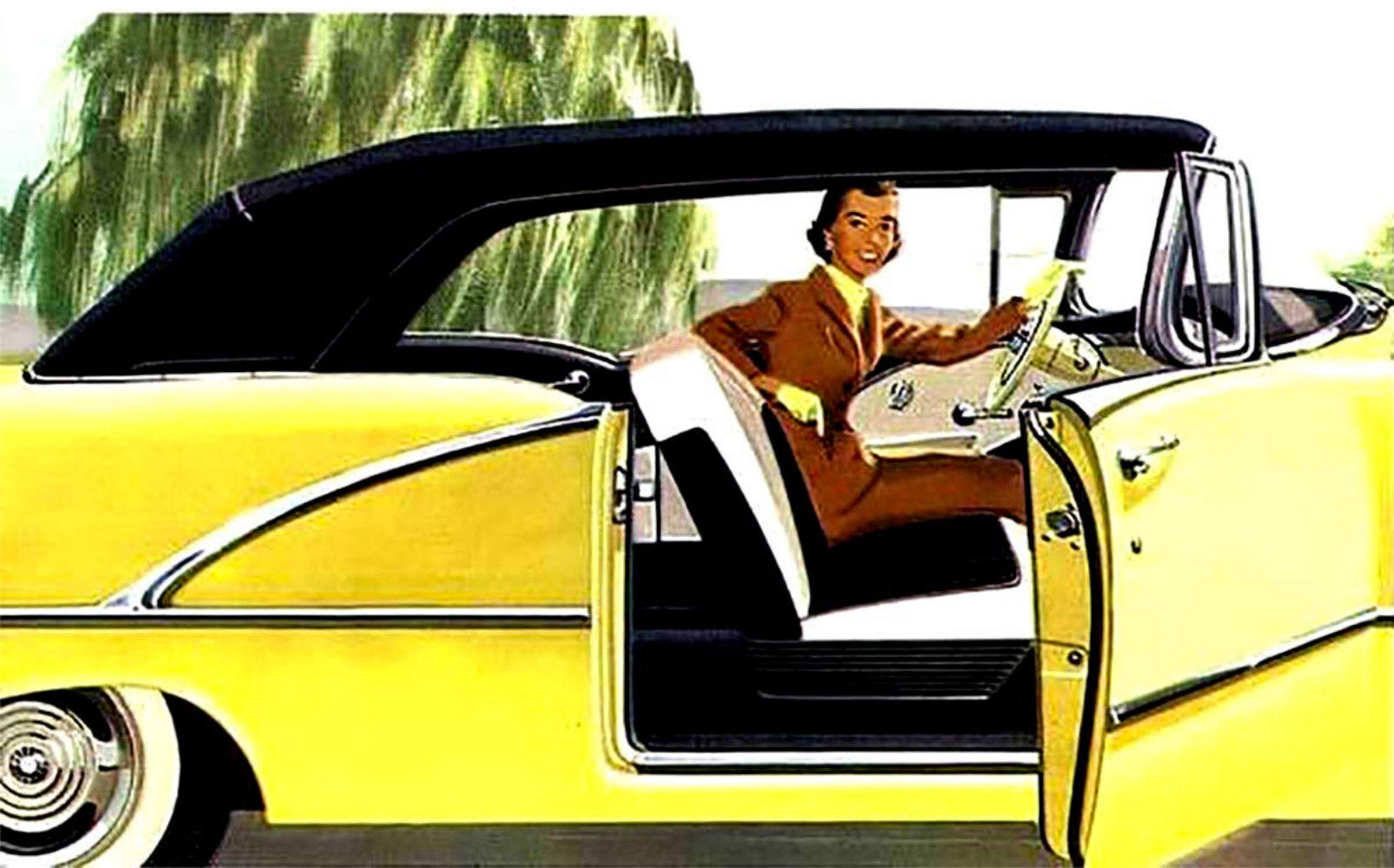
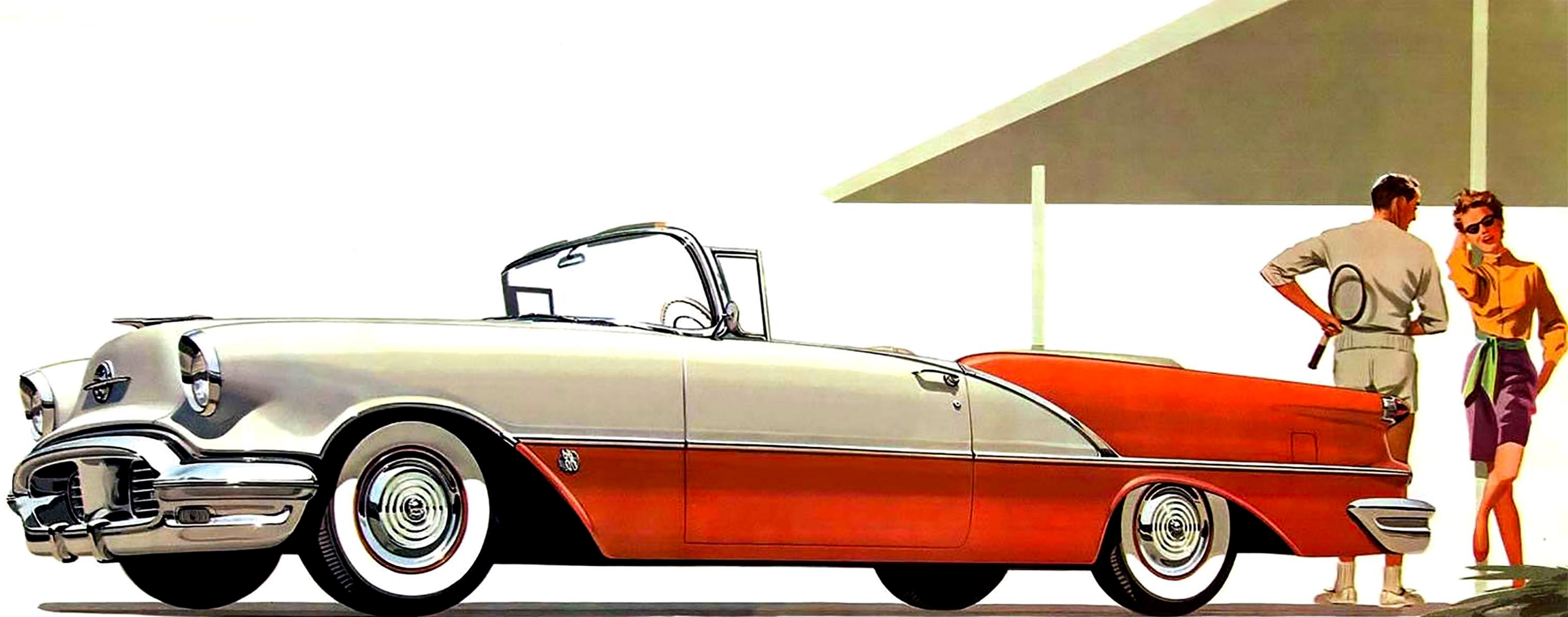

Sportsmen ahoy! For the thrill of your life is here just waiting for a lean, tanned hand to guide it! Out for the fun of it . . . out for the sun of it!

**SUPER '88" CONVERTIBLE COUPÉ**

**SUPER '88" SPECIFICATIONS**

Wheelbase, 122" • Over-all Length, 203.29" • Over-all Width, 78.62" • Over-all Height (5-pass. load): 4-Door Sedan, 60.54"; 2-Door Sedan, 60.5"; Holiday Coupé and Convertible Coupé, 59.3"; Holiday Sedan, 59.8" • Tire Size, 7.60 x 15.



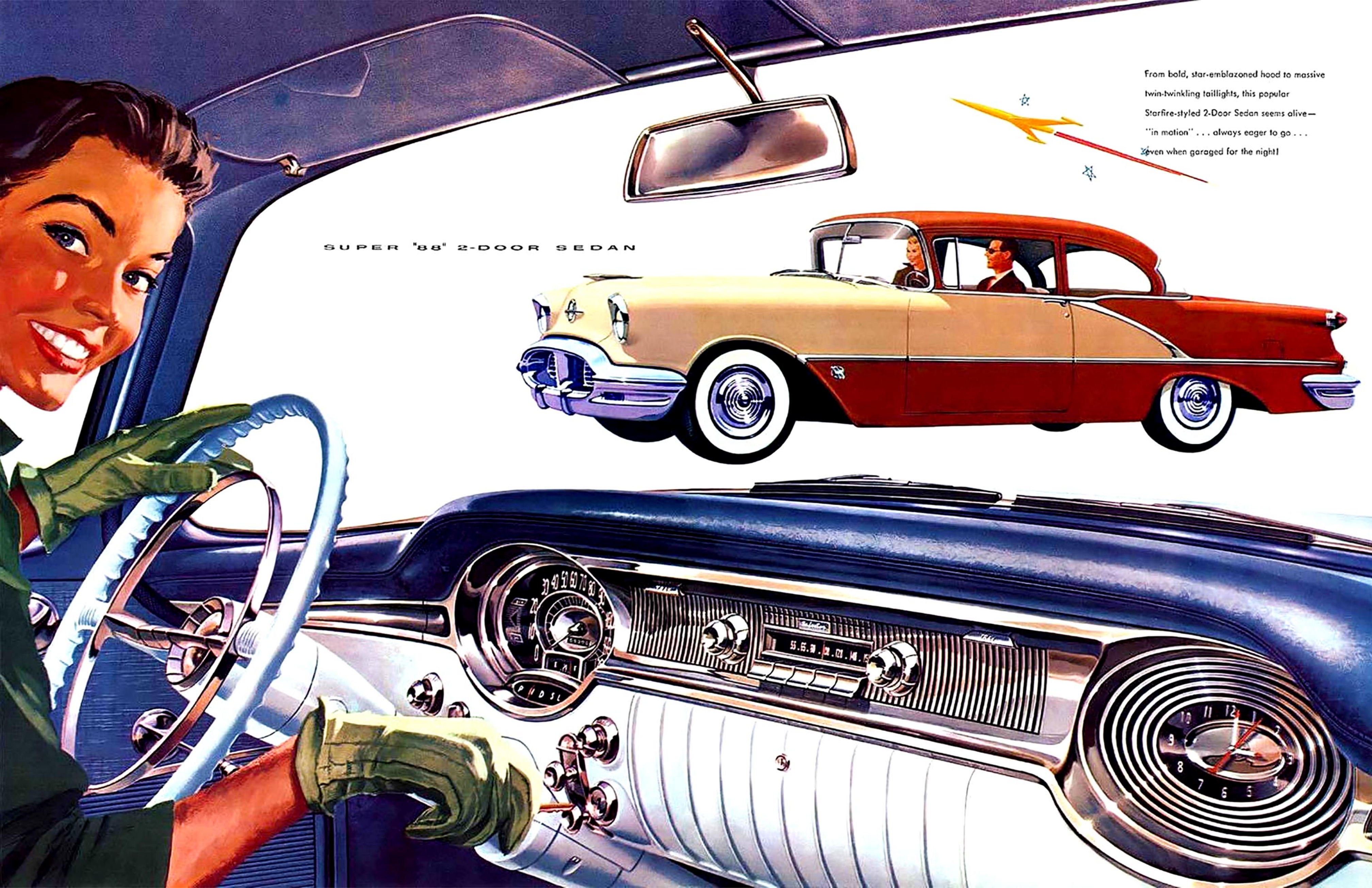

SUPER "88" 2-DOOR SEDAN

From bold, star-embazoned hood to massive twin-twinkling taillights, this popular Starfire-styled 2-Door Sedan seems alive—"in motion" . . . always eager to go . . . Even when garaged for the night!





NINETY-EIGHT BY OLDSMOBILE

The Fine Line of Distinction

Please note the decided difference in the styling and design of the Ninety-Eight Holiday Coupé. This difference, we believe, creates a new fashion for the highway . . . further serving to set the Ninety-Eight apart and distinct from the crowd in appearance, luxury and performance!



Here is comfort above all . . . and interior color selections ranging from subtle and subdued to bright and contrasting patterns.

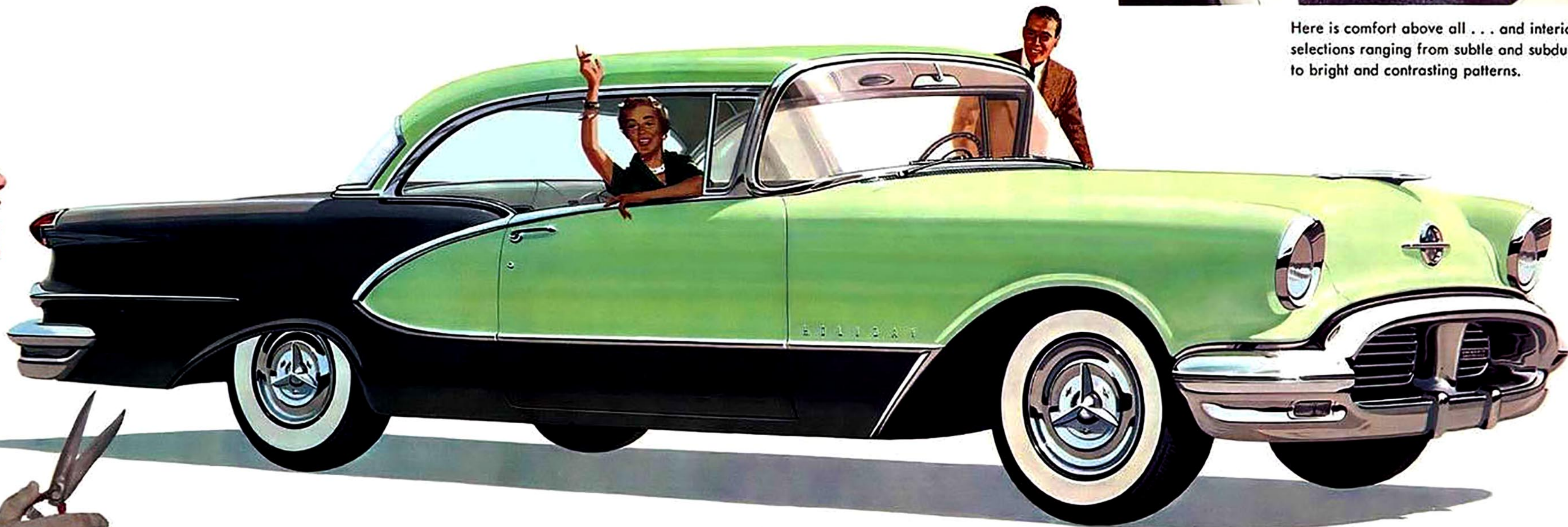

NINETY-EIGHT DE LUXE HOLIDAY COUPÉ



NINETY-EIGHT DE LUXE HOLIDAY SEDAN

All's clear from panoramic  
windshield to rear support columns.  
There's full view for driver and  
passengers alike . . . with beauty  
and comfort that know no bounds!

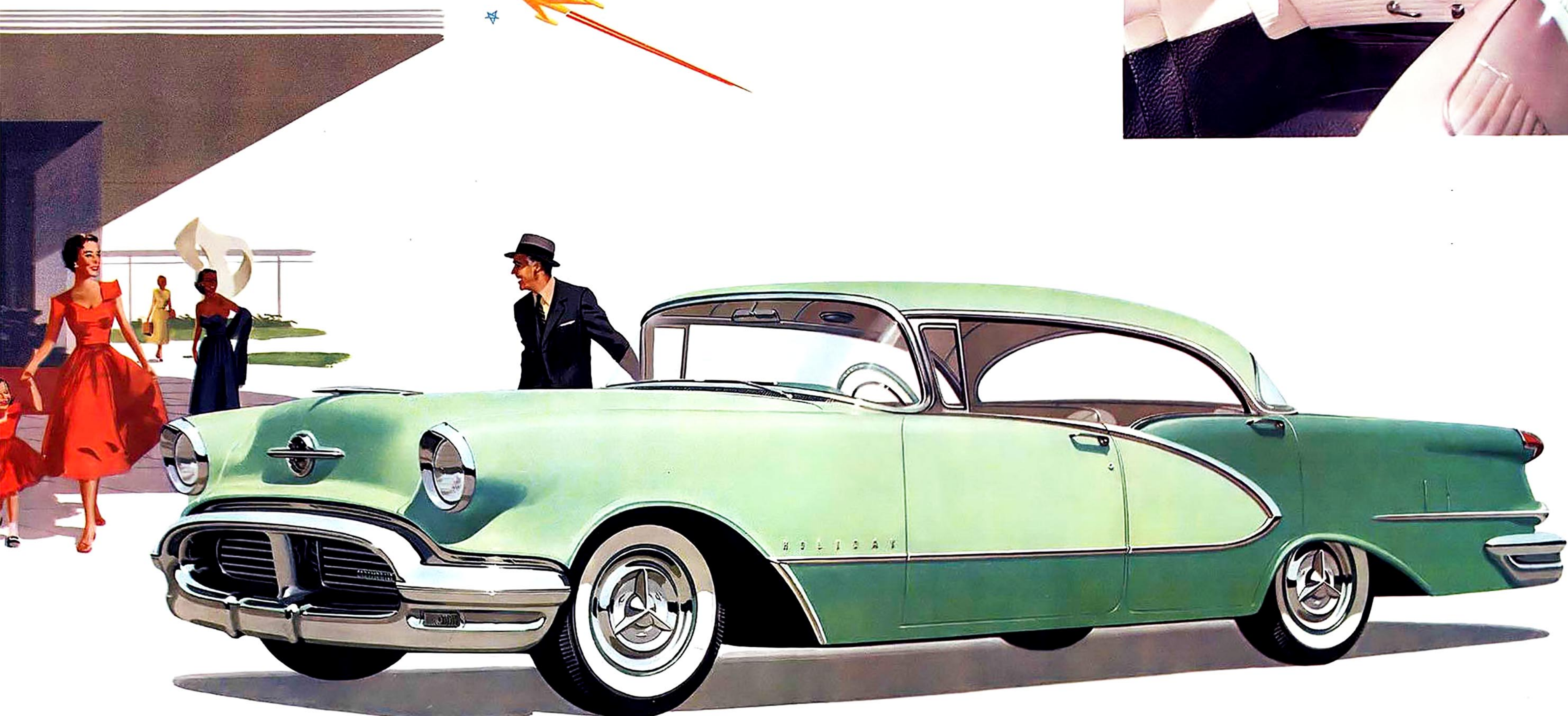

The full meaning of "The Fine Line of Distinction" is nowhere more apparent than



NINETY-EIGHT

# Starfire

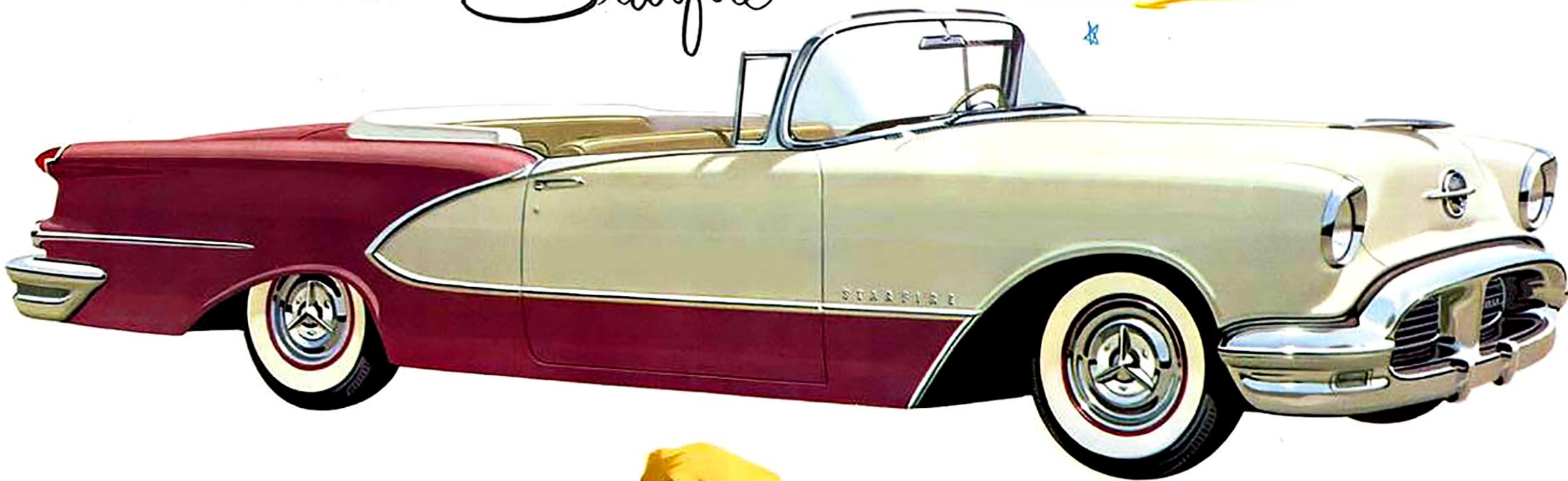

Starfire! A glowing tribute to those who hear the call of the open road. This Ninety-Eight Convertible is tooled and leathered . . . fashioned and engined . . . for the sheer joy of driving!

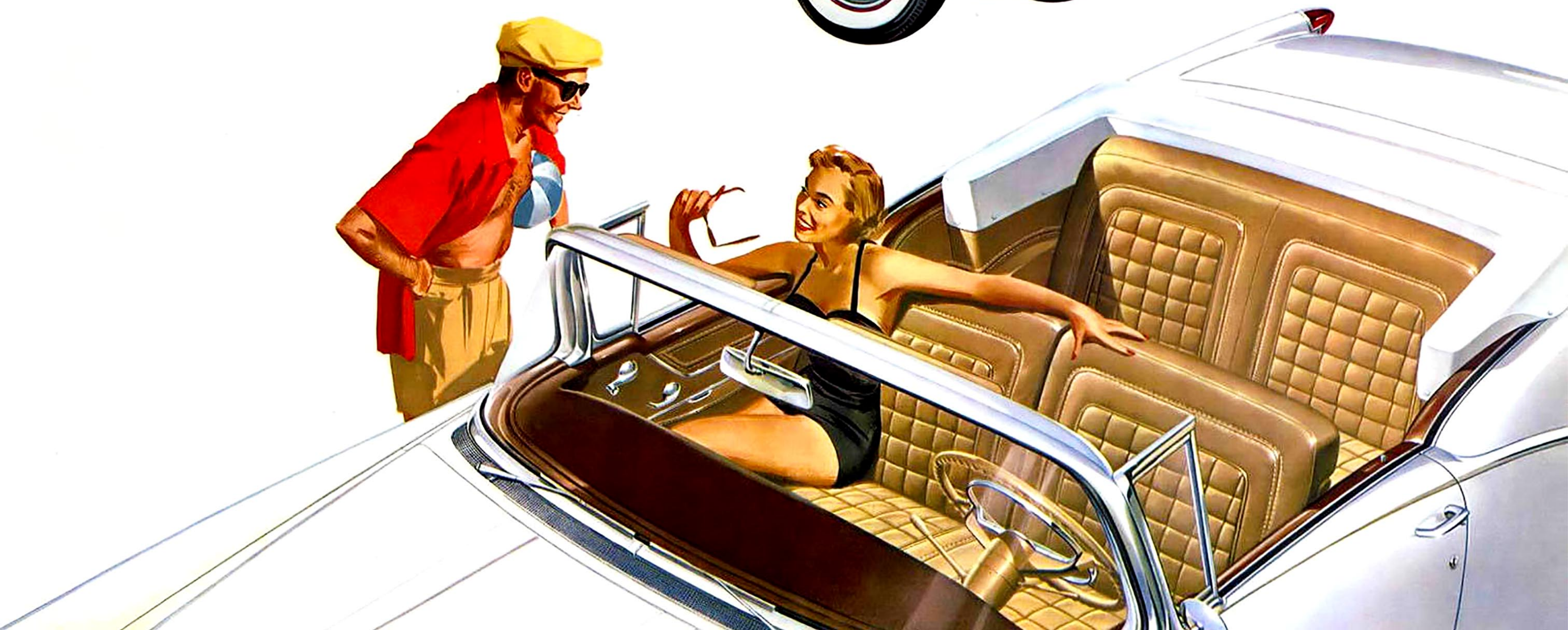



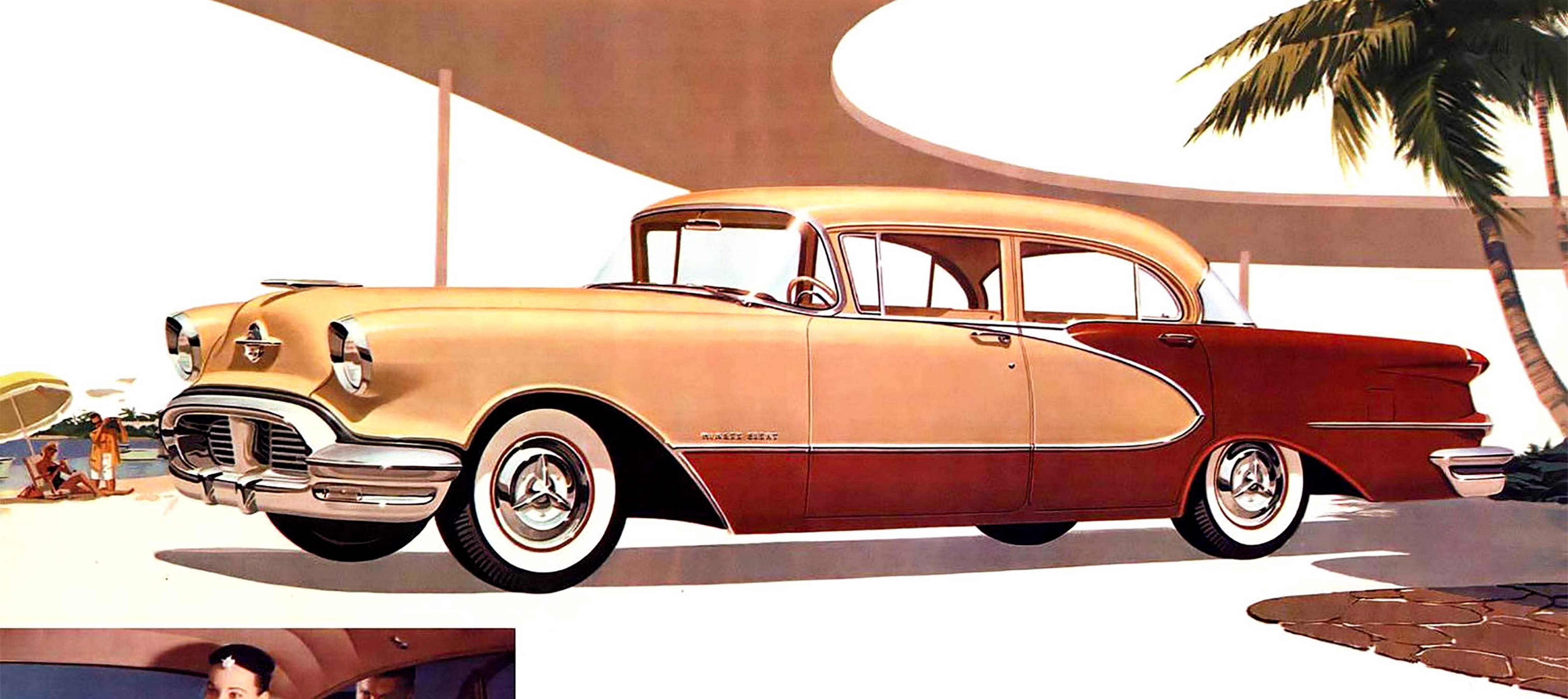

**NINETY EIGHT 4-DOOR SEDAN**



Unlimited luxury, pleasure and prestige are personified in the distinguished Oldsmobile Ninety-Eight Four-Door Sedan —the ultimate in good taste.

**NINETY-EIGHT SPECIFICATIONS**

Wheelbase, 126" • Over-all Length, 212.29" •  
 Over-all Width, 78.62" • Over-all Height (5-pass. load):  
 4-Door Sedan, 60.54"; De Luxe Holiday Coupé and  
 Starfire, 59.3"; De Luxe Holiday Sedan,  
 59.8" • Tire Size, 7.60 x 15 (Starfire, 8.00 x 15).





Here's where rare beauty and true value meet . . . to give you Starfire styling at a popular price.



'88' HOLIDAY COUPE

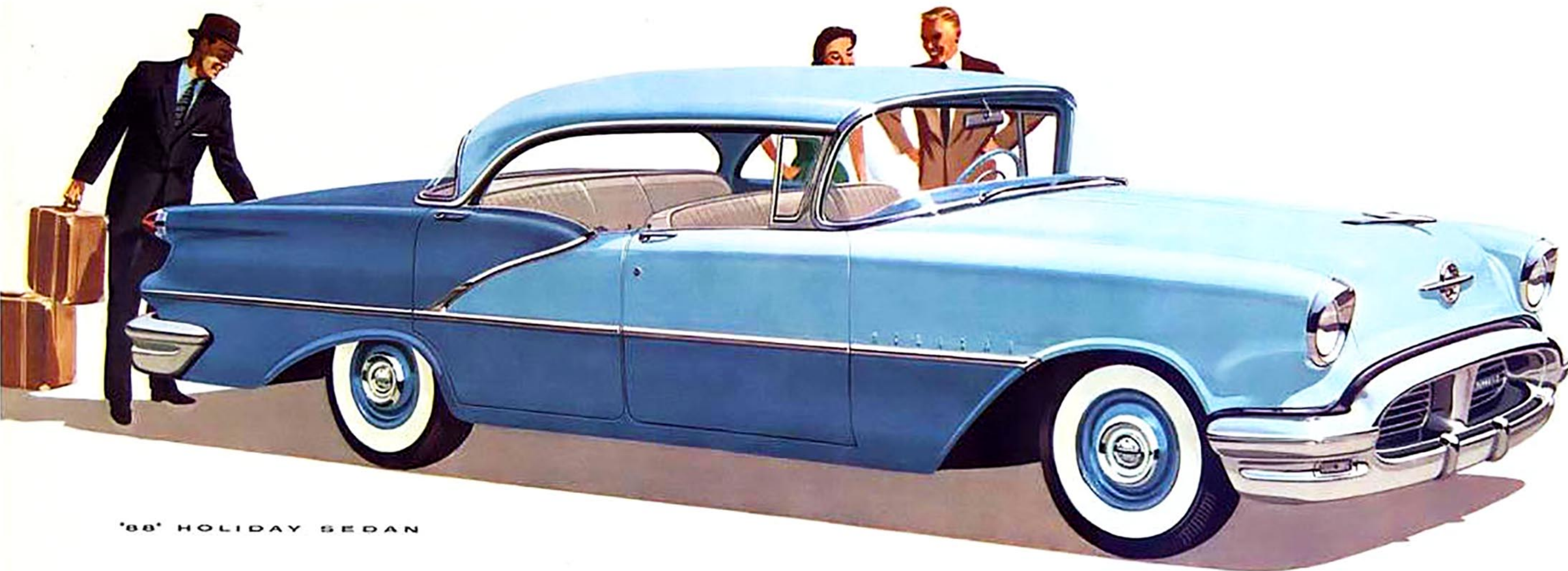
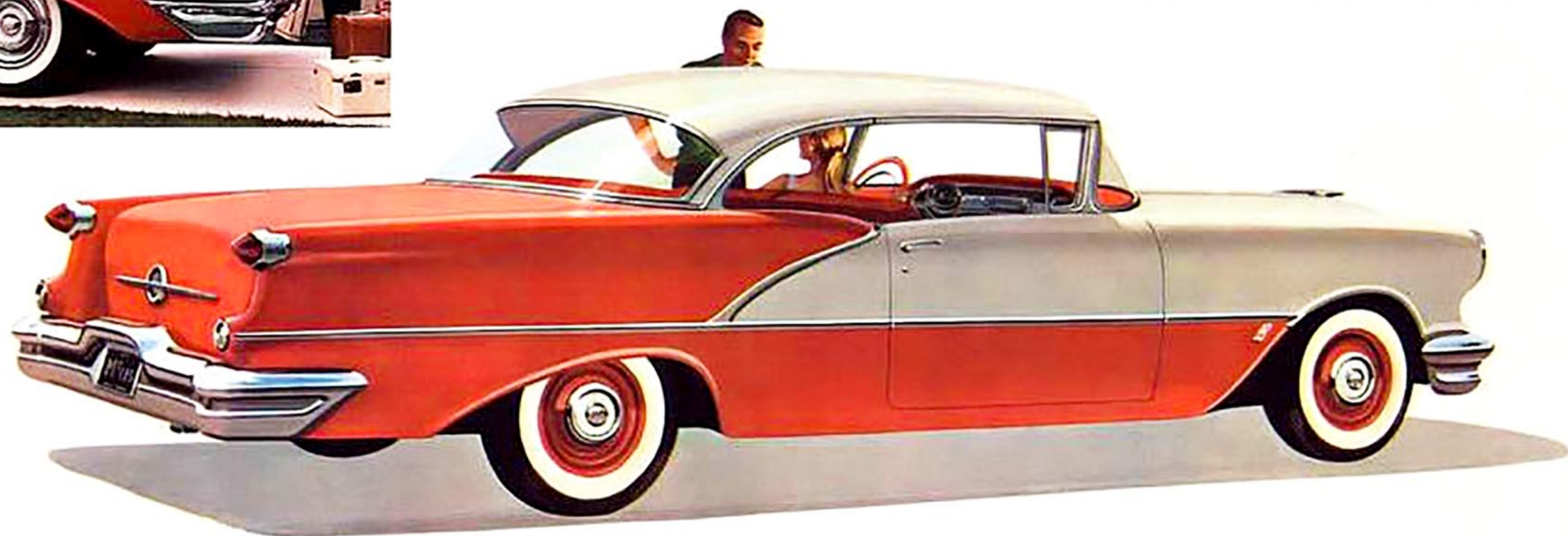

'88' HOLIDAY SEDAN



If it's full-view beauty and true-blue value you want, select one of these two handsome Holiday hardtops . . . get out of the ordinary and into an Olds! Start with one of these glamorous Holidays if you've never owned an Olds before. For it's here you'll learn what others know already. The '88' is an Oldsmobile through and through . . . but an Olds priced down where it's fun to start!

OLDSMOBILE '88' • Beauty and Value are the buy-words here !

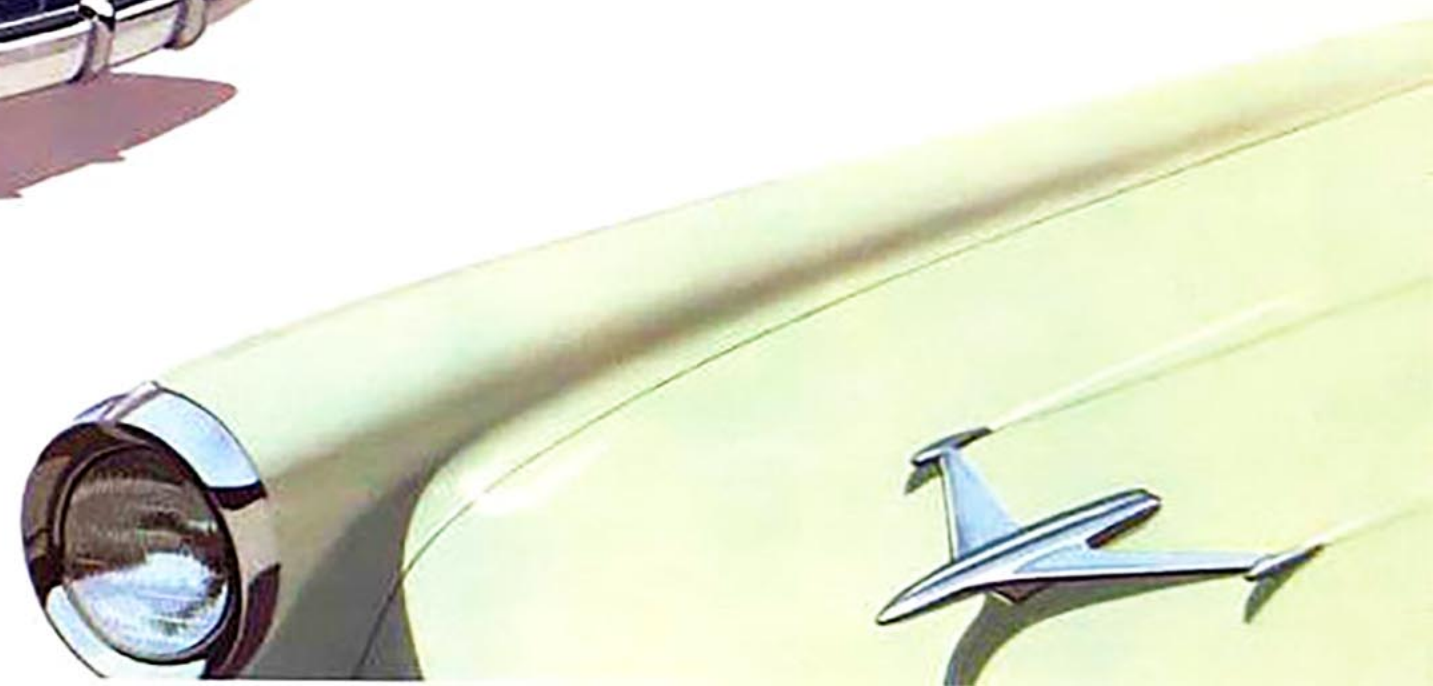





'58' 4-DOOR SEDAN

**SERIES '58' SPECIFICATIONS**

Wheelbase, 122" • Over-all Length, 203.29" • Over-all Width, 78.62" • Over-all Height (5-pass. load): 4-Door Sedan, 60.54"; 2-Door Sedan, 60.5"; Holiday Coupé, 59.3"; Holiday Sedan, 59.8" • Tire Size, 7.10 x 15 • Powered by 230-h.p. Rocket Engine with Rocket T-350 Engine optional at extra cost.

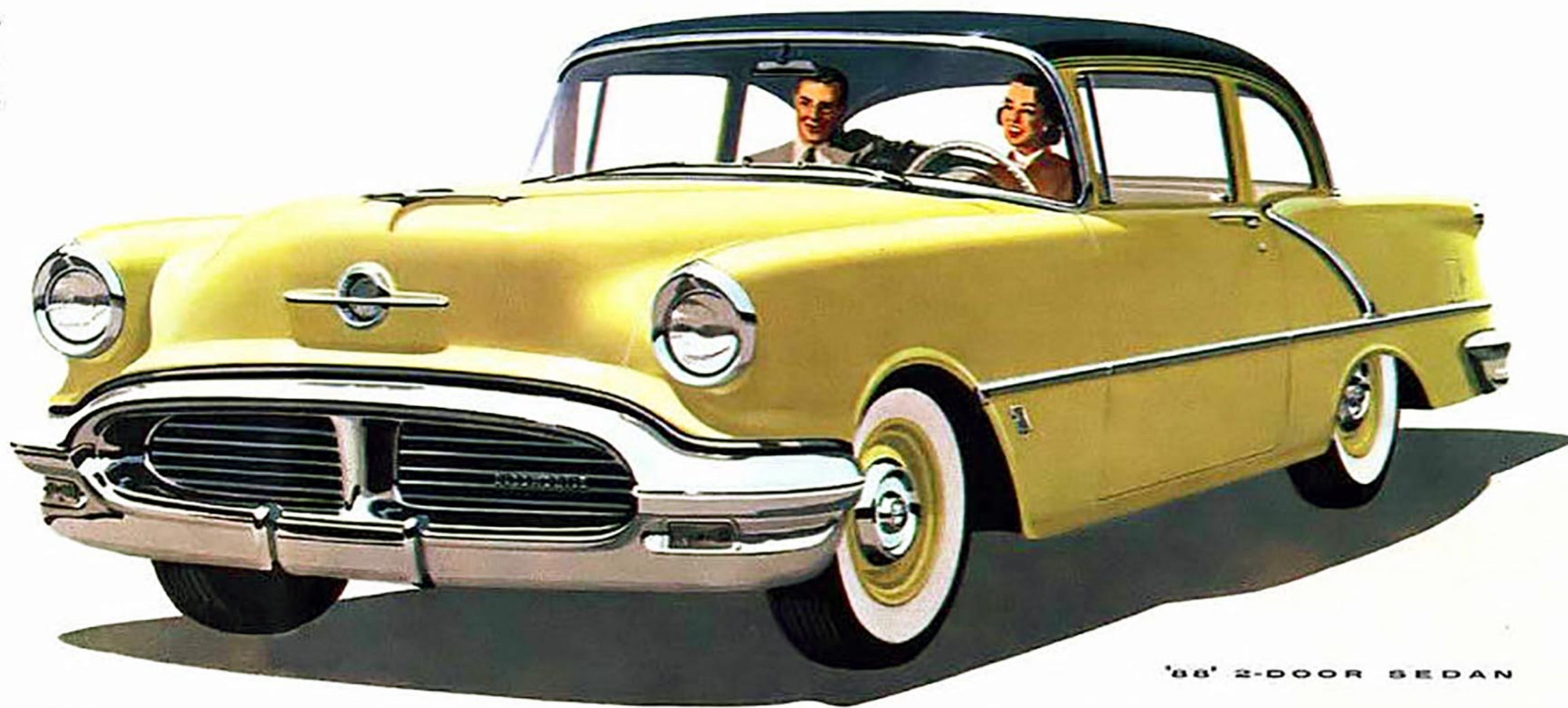
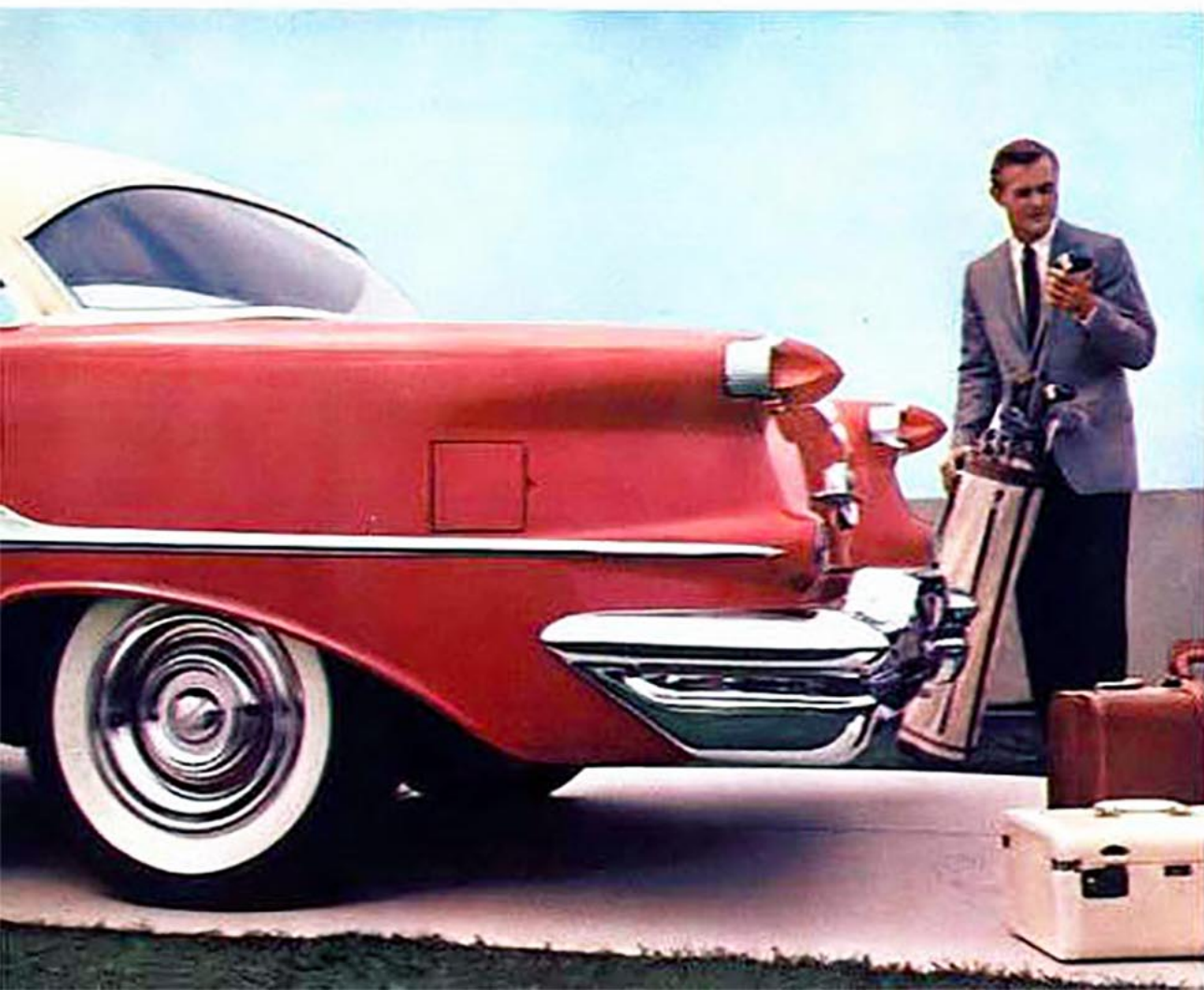

'58' 2-DOOR SEDAN

Let yourself go . . . for a glamorous, glorious Olds "58" that's ready to go for you! Thrill to its rocket-away power . . . radiant beauty . . . big-family roominess . . . all at a low budget price.



# NEW ROCKET T-350 ENGINE

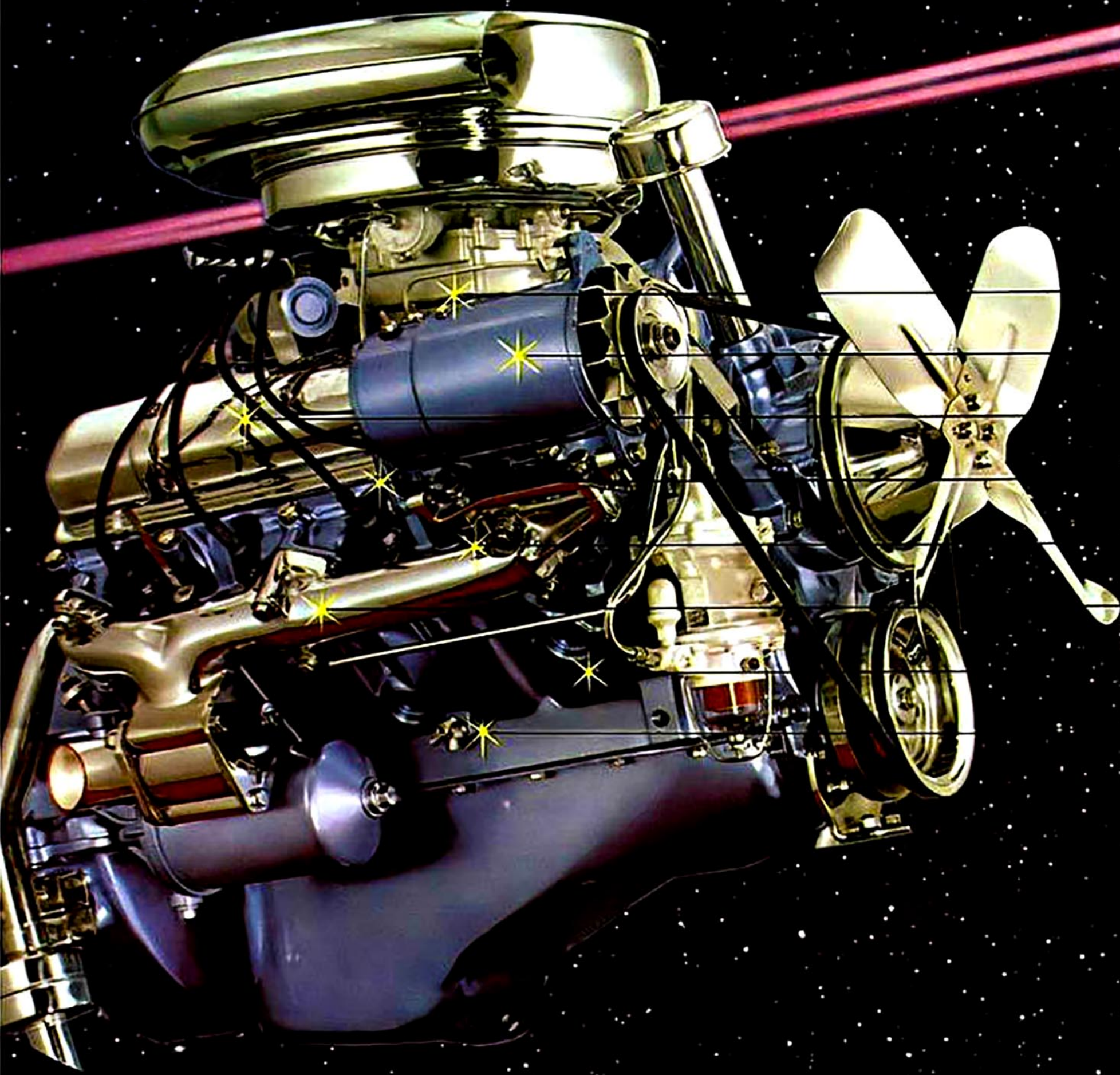

NEW QUADRI-JET CARBURETOR

NEW HIGHER TORQUE

NEW LARGER INTAKE AND EXHAUST VALVES

NEW HIGHER-LIFT CAMSHAFT

NEW HYDRAULIC VALVE LIFTERS

NEW HIGHER HORSEPOWER

NEW HIGHER-COMPRESSION

NEW ROCKER ARM LUBRICATION

"T" stands for torque . . . and it's terrific in the new Rocket T-350 Engine! In every respect, this is the mightiest Rocket of all times with its ever-ready safety reserve of flashing power. Compression ratio steps up to a new high of 9.25 to 1. And the Rocket T-350 brings you 240 eager horsepower! Major advances in valving and carburetion result in super-quiet, powerfully smooth action in every speed range—with all of the Rocket's well-known economy. Just try it!

## ENGINE SPECIFICATIONS

Type.....	Rocket T-350, High-Compression 90°-V Type, 8 Cylinders
Horsepower.....	240 @ 4400 r.p.m. in Ninety-Eight and Super "88" models; 230 @ 4400 r.p.m. in "88" models
Taxable Horsepower.....	48
Torque (pound-feet).....	350 @ 2800 r.p.m. in Ninety-Eight and Super "88" models; 340 @ 2400 r.p.m. in "88" models
Compression Ratio.....	9.25 to 1
Bore and Stroke.....	3 7/8" x 3 7/16"
Piston Displacement.....	324.3 cu. in.
Pistons (Auto-Thermic type).....	Aluminum Alloy
Valves.....	Overhead; Hydraulic Lifters
Cooling System (capacity, with heater).....	21.5 qts.
Lubrication System.....	Full Pressure
Electrical System.....	12-volt
Fuel System.....	Quadri-Jet Carburetor (Dual-Downdraft on "88" models); Fuel Tank Filter

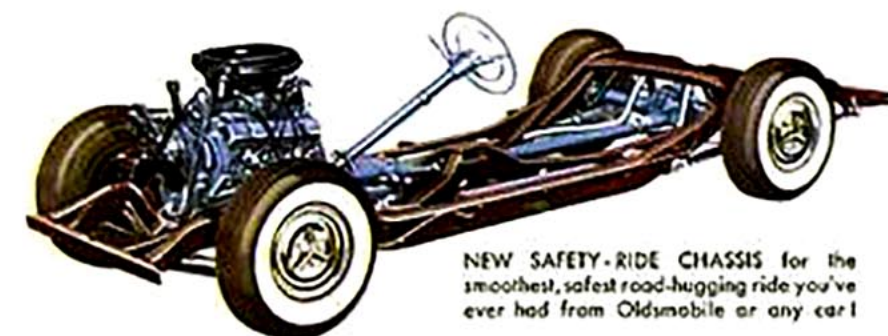

NEW SAFETY-RIDE CHASSIS for the smoothest, safest road-hugging ride you've ever had from Oldsmobile or any car!

## CHASSIS SPECIFICATIONS

Frame.....	Deep Channel-Section Side Rails; I-Beam X-Center-Member; 5 Cross Members
Front Suspension.....	Independent Linked Parallelogram with Coil Springs; Direct-Acting Shock Absorbers; Stabilizer Bar
Rear Suspension.....	58" x 2 1/8" Leaf Springs; Angle-Mounted Direct-Acting Shock Absorbers; Stabilizer Bar
Brakes.....	Super-Hydraulic; 191.7-sq.-in. Lining Area; Pedal-Operated Parking Brake
Synco-Mesh Transmission.....	Standard on "88" models
Jetaway Hydra-Matic Drive.....	Standard on "98" and Super "88"
Steering.....	Dual Center-Control; Recirculating Ball-Nut Gear
Steering Turning Circle (diameter).....	"88" and Super "88"—42.0 ft.; Ninety-Eight—43.0 ft.
Rear Axle.....	Semi-floating; Hypoid Gears



**NEW**  
**JETAWAY**  
**HYDRA-MATIC DRIVE**

ALL THE *Flow* OF FLUID...  
 ALL THE *Go* OF GEARS!

This is new Jetaway Hydra-Matic Drive by Oldsmobile . . . pioneer of automatic transmissions . . . with more years of experience than any other! To world-famous Hydra-Matic, Olds engineers have added a *second* fluid coupling, which combines a new, silky smoothness of operation with the power, performance and economy all Hydra-Matic owners know so well. With Jetaway there is no jerk, no jump, no noise, no whirr. There is nothing but the smoothest

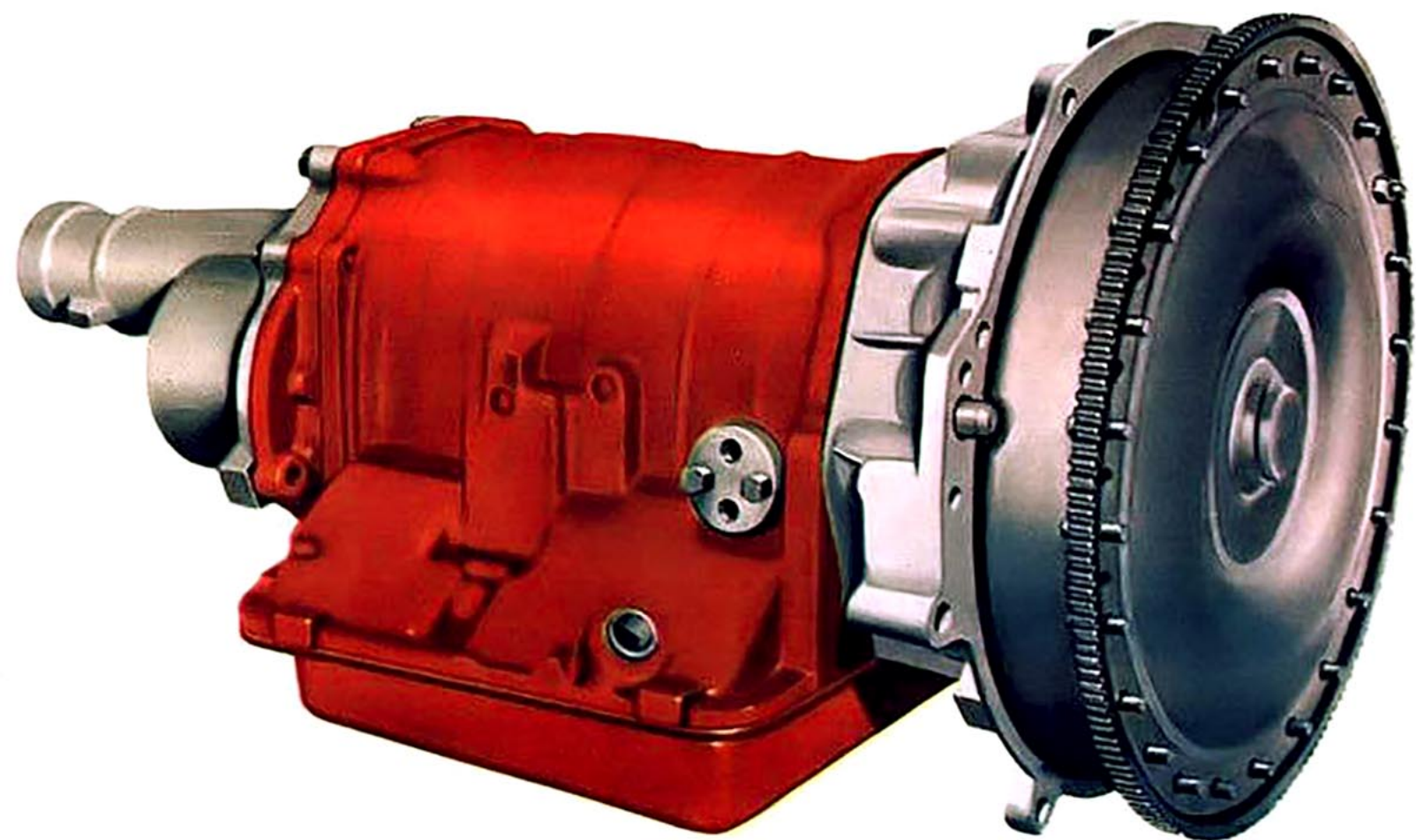

THE SECRET OF THE SMOOTHNESS IS IN THE SECOND COUPLING!

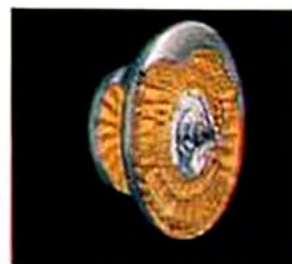
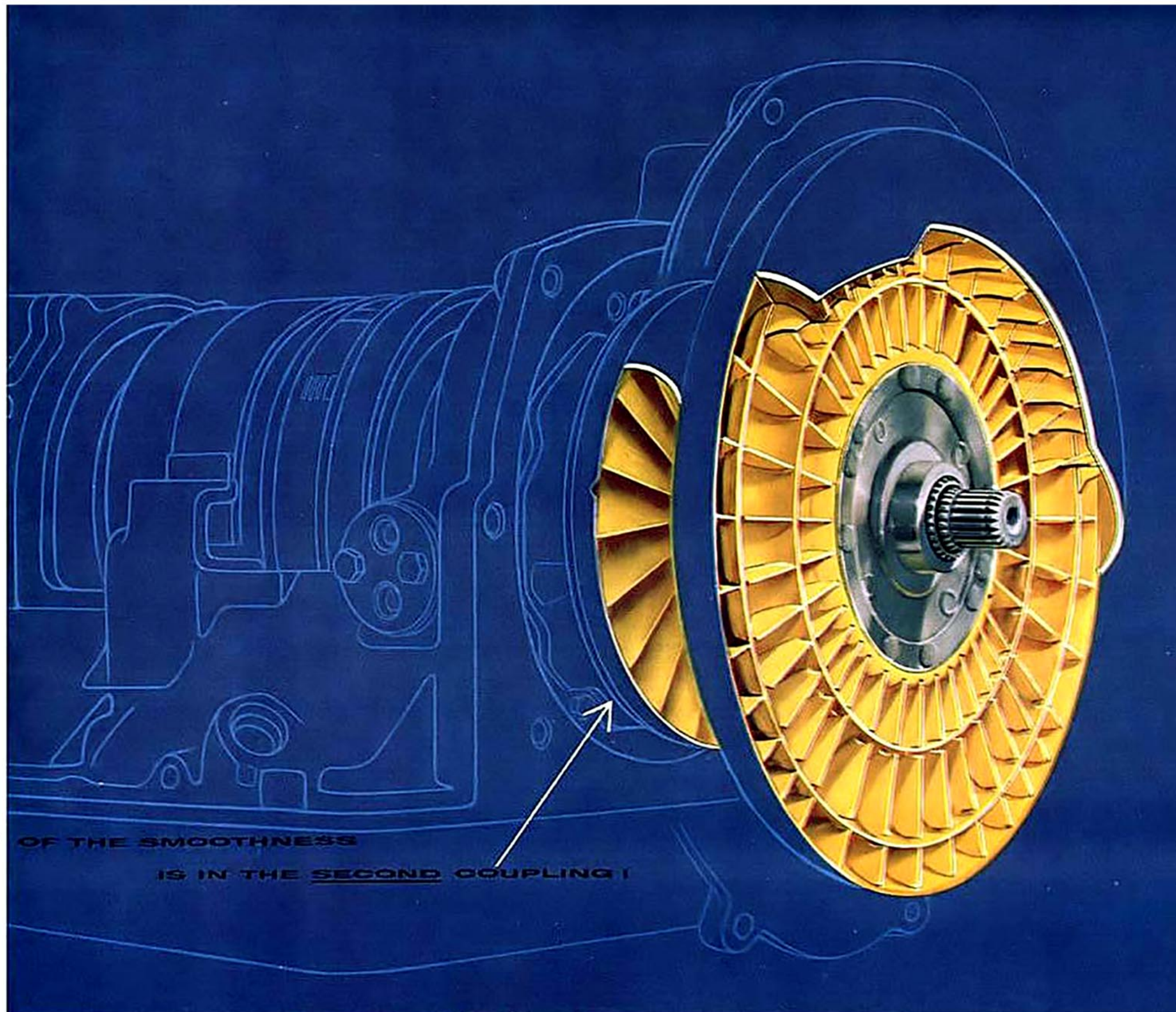

Two couplings . . . twice the smoothness! And Jetaway's positive gear action prevents slippage, increases economy!

flow of power imaginable from the new Rocket T-350 Engine to the wheels of your Oldsmobile . . . to give you rocketing getaway! Jetaway also features a safe, new, automatic downshift gear that pours on power when you need it . . . smoothly, without pause. New Jetaway Hydra-Matic Drive is best appreciated after you've tried it yourself—in the 1956 Oldsmobile. You're invited to try it now!

NEW 6-POSITION SELECTOR indicator for Jetaway Hydra-Matic always tells you what gear you're in. And the new positive "Park" position means added convenience and safety.



QUICK GETAWAY WITH JETAWAY! Never so smooth . . . never so fast! Jetaway Hydra-Matic Drive translates 240 Rocket horsepower into action whenever you need it!

NEW DOWNSHIFT GEAR works wonders on the highway when you want that extra surge of power. Simply press the accelerator halfway down . . . and a burst of smooth power is yours!



SMOOTH JETAWAY . . . smooth getaway! Now there are two fluid couplings! Result: new velvet-smoothness . . . one continuous flow of power right up to top speed!



# Oh-h-h ! those beautiful OLDSMOBILES

... inside and out !

Instrument cluster is artfully arranged so driver can see safety signal lights for ammeter, oil pressure, water temperature . . . car speed, fuel gauge, and Jetaway Hydra-Matic Selector—all at a split-second glance.

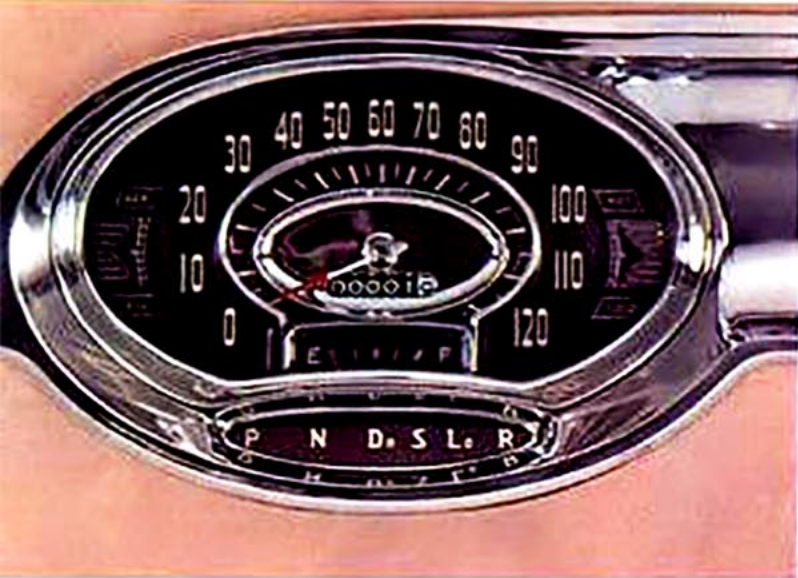

New, wider-than-ever glove compartment . . . sweep-blended into instrument panel . . . provides room galore for odds-and-ends to make motoring more comfortable. And it's right at your finger tips!

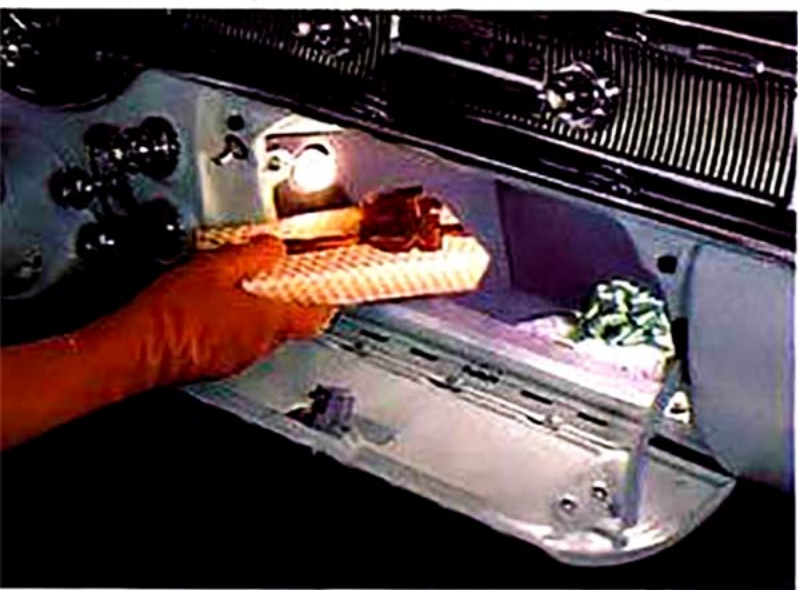

Put your foot down on Oldsmobile's new foot-operated pedal parking brake and the brake stays on till you release it by an easy-to-operate knob on the dash. Only a little pressure is required to set foot pedal firm to stay!



Look what's new in the '56 Oldsmobiles—new signal lights for oil pressure, water temperature and ammeter—new star-studded steering emblem—recessed, pivot-type ash trays—safety-padded instrument panel—new wider, safer rear view mirror—new electric clock with sweep second hand!

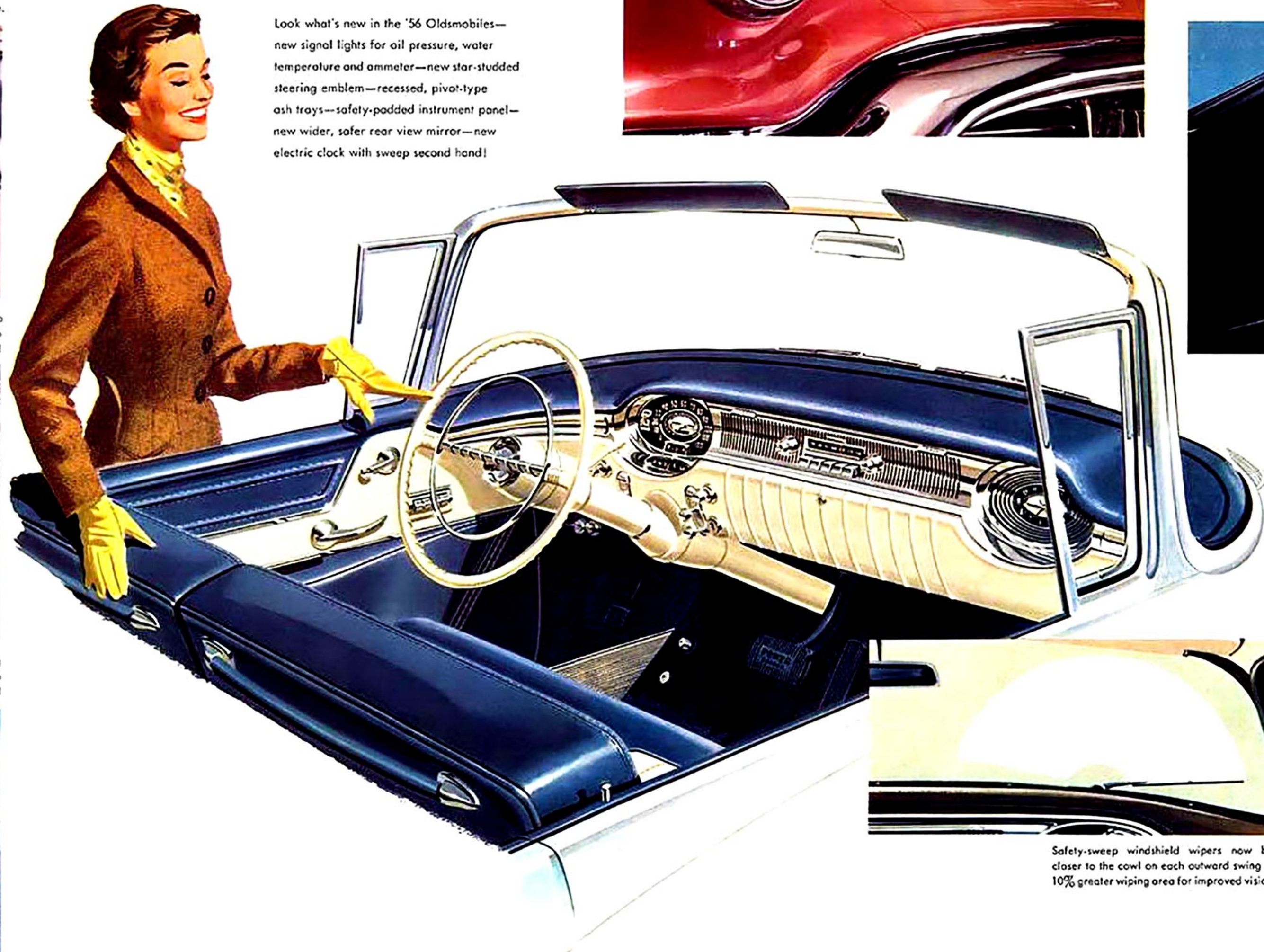

Bolder hooded headlights are incorporated with sweeping front flair-away fenders. Headlamps are new T-3 Safety-Aim to give more light . . . aimed right! You get better illumination at right side of road on "low" beam . . . reduced glare and better lighting in rain or fog. Parking lights are integral with front bumper.

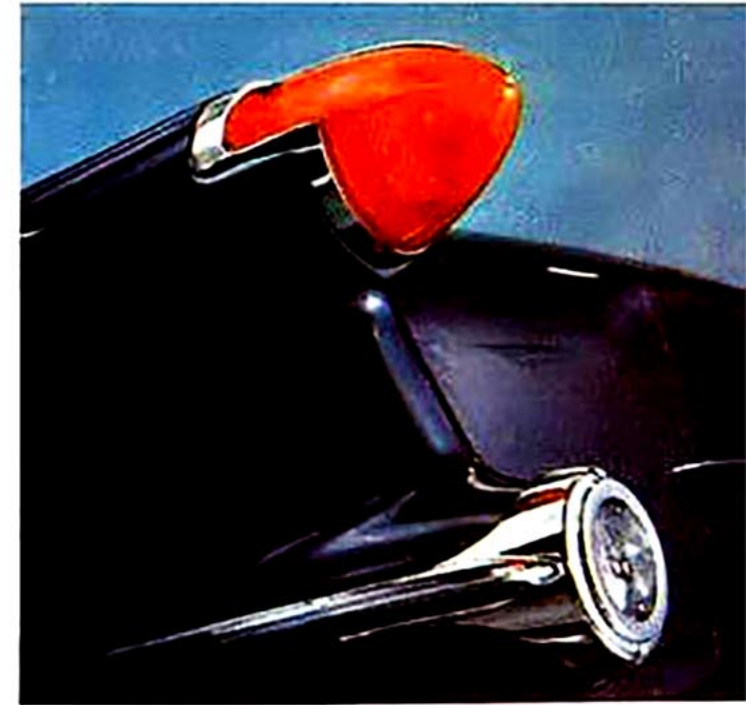

New projectile-shaped taillights set off the Starfire styling that gives the '56 Oldsmobile its "in-flight" tapered appearance . . . new back-up lamps focus wide areas of white light where you need it for safer, easier backing.



Safety-sweep windshield wipers now bring blades closer to the cowl on each outward swing . . . covering 10% greater wiping area for improved vision and safety.



Quiet, commanding power ... at your beck-and-call !



Oldsmobile's new Safety Power Steering with automatic "Co-Pilot" requires only the lightest of touches (two pounds pressure) to command it wherever you turn! New automatic "Co-Pilot" feature helps you turn the wheel while parking ... requires less steering effort while maneuvering, taking corners and curves. Safety Power Steering means the safest, surest steering ever!

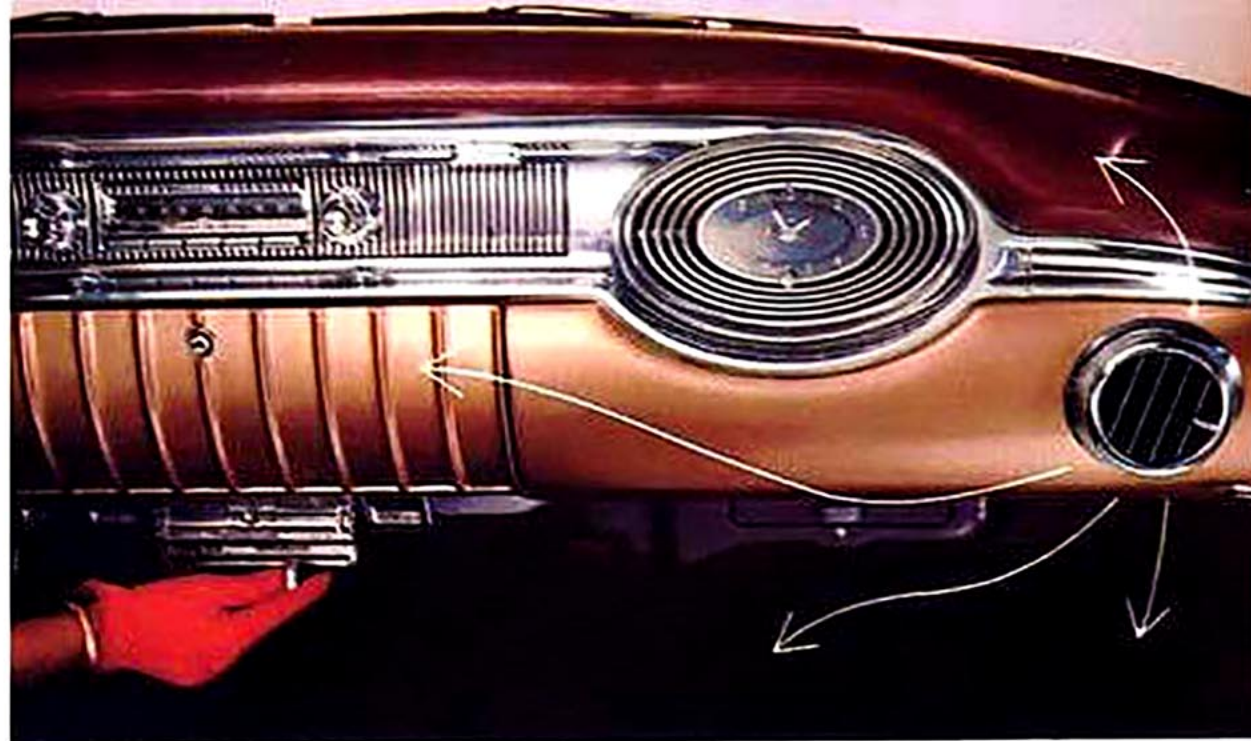
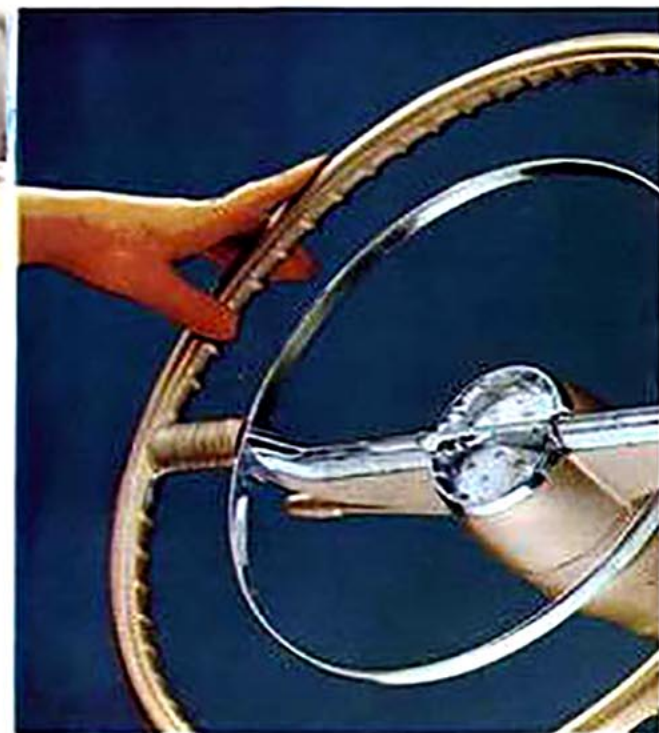

OLDSMOBILE'S AIR CONDITIONING for '56—the quickest-acting, most effective system in the industry—floods car's interior with cool, comfortable air through three large cool-air outlets. Lower-than-ever temperatures can be reached almost instantly—and maintained

even during hottest weather. Incoming and recirculated air is 100% filtered. Dehumidifier maintains ideal humidity—even in wet weather—for refreshing, all-weather motoring. Complete under-hood installation means no sacrifice of luggage compartment space.



CONDITION-AIR HEATER, with thermostatic control, distributes warmed air evenly throughout car interior. Defroster unit quickly clears windshield of ice or frost.



OLDSMOBILE SUPER DE LUXE RADIO provides automatic signal-seeking control bar and push-button selector for finger-tip tuning. Rear compartment speaker is optional.

## OLDSMOBILE ACCESSORIES

All Oldsmobile accessories are styled and designed to make your motoring more enjoyable, more comfortable, more convenient, and above all, safer.



The mere touch of your toe results in safe-sure stopping power with Oldsmobile Pedal-Ease Power Brakes. Braking effort is greatly reduced to make driving much easier. There is a generous reserve of vacuum power for braking with engine off.

All-electric power window controls on the '56 Oldsmobile raise and lower windows at the touch of a finger. Separate controls for each window with a master panel on the driver's door.

New hydraulically controlled radio antenna can be lowered or raised automatically at driver's convenience for best reception in town or country!

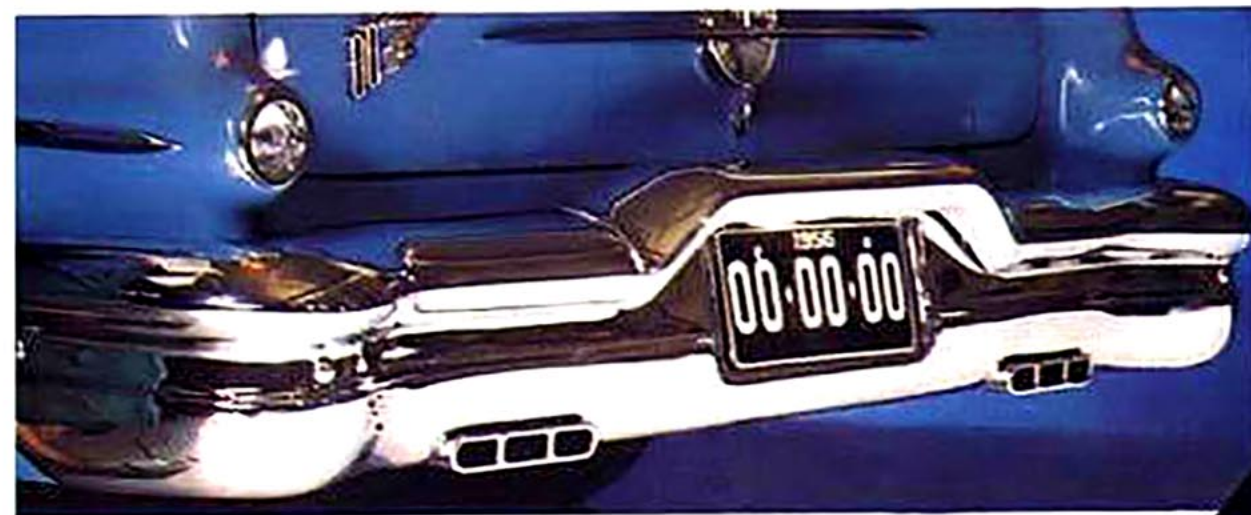

NEW DUAL EXHAUST SYSTEM (factory-installed only) steps up fuel economy, increases usable horsepower and engine torque by reducing exhaust back-pressure to a minimum.

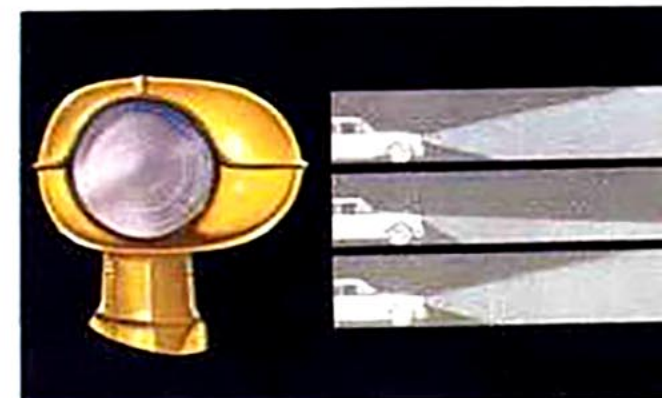

OLDSMOBILE'S AUTRONIC-EYE automatically dims your headlights, then brings them back to "bright" when oncoming traffic clears. New foot switch gives you manual control, too.

Oldsmobile's new 6-Way Electric Power Seat Control gives you full power seat adjustment, not only forward-and-backward and up-and-down, but tilt-forward and tilt-backward positions—automatically!



NEW DE LUXE WHEEL DISCS of glistening stainless steel add beauty and distinction to the 1956 Oldsmobile of your choice.







OLDSMOBILE