

# 63 Pontiac Accessories

# '63 Pontiac Accessories

For your convenience, Pontiac has grouped a number of its most popular engineer-approved accessories. Each of the following groups will be factory installed on your car during assembly, thereby saving you not only installation costs but valuable time as well.

## **PONTIAC BASIC GROUP**

Super De Luxe Radio—Manual Antenna  
Dual Speed Electric Wipers  
Electric Windshield Washers  
Custom Foam Cushion (Front only)  
Back-Up Lamps  
Heavy Duty Air Cleaner and Silencer

## **LAMP GROUP**

Luggage and Utility Lamp (Except Safari)  
Parking Brake Warning Lamp  
Dome and Reading Lamp  
Glove Compartment Lamp  
Cigar Lighter and Ash Tray Lamps  
Instrument Panel Courtesy Lamp

## **SAFETY GROUP**

Safeguard Speedometer and Fuel Level Lamp  
Instrument Panel Pad (Catalina and Star Chief only)\*\*  
Seat Belts—Front Pair

## **MIRROR GROUP**

Inside Non-Glare Tilt Mirror  
Remote Control Outside Mirror  
Visor Vanity Mirror

## **PROTECTION GROUP**

Door-Edge Guards  
Floor Mats (Front and Rear)  
Spare Tire and Wheel Cover (Catalina—except Safari and Star Chief)

## **DECOR GROUP—CATALINA MODELS ONLY**

Catalina Vista Custom Exterior Trim  
Catalina Sports Sedan Custom Exterior Trim  
Catalina Sports Coupe Custom Exterior Trim  
Catalina Sedan Custom Exterior Trim  
Catalina 6- and 9-Passenger Safari Custom Exterior Trim  
Custom Steering Wheel  
De Luxe Wheel Discs

## **PONTIAC OPTIONS**

Power Window Lift  
Power Operated Vent Windows (Bonneville and Grand Prix only)  
Power 6-Way Seat  
Wonder-Touch Power Brakes  
Wonder-Touch Power Steering  
Aluminum Wheel Hubs and Brake Drums  
Engine Options  
Soft-Ray Glass  
Pontiac Hydra-Matic  
Cruise Control  
Safe-T-Track Differential  
Bucket Seats

## **PONTIAC INDIVIDUAL ACCESSORIES**

Full Width Floor Mat (Front only)  
Tri-Comfort Circ-L-Aire Air Conditioner  
Pontiac Electric Clock (Catalina only—except with air conditioning)  
New Tilting Steering Wheel  
Pontiac Car Compass

New Verbra-Phonic Rear-Seat Speaker  
Rear Door Safety Lock (4 Door models only)  
New Pontiac FM-AM Radio—Manual Antenna  
Electric Power Antenna  
Separa-Phonic Rear Seat Speaker System (Except Safari)  
Cushion Topper  
Clear Plastic Seat Covers  
Pontiac Tissue Dispenser  
Outside Rear-View Mirror  
Vent Shades  
Dual Exhaust—Except Grand Prix  
Gas Cap Lock  
Spot Lamp  
Remote Control Trunk Lid Release (Except Safari)  
Pontiac "No Mar" Fuel Door Guard  
Sports Wheel Cover  
Wire Wheel Discs  
Custom Wheel Discs  
White Sidewall Tires (Tubeless)  
Tachometer  
Guide-Matic Headlamp Control  
Underhood Lamp (Except Safari)  
New Tonneau Cover

## **PONTIAC SAFARI**

Power Tailgate Window  
Tailgate Window Screen  
Rear Door Window Screen  
Rear Load Area Pad  
Chrome Luggage Carrier

**(F)** FACTORY INSTALLED  
**(D)** DEALER INSTALLED  
**(FD)** FACTORY OR DEALER INSTALLED

**NOTE:** All accessories featured as part of a group may be purchased as individual factory installed items if desired, with the exception of the Catalina Exterior Trims.

\*\*Standard on Bonneville and Grand Prix.

# PONTIAC BASIC GROUP

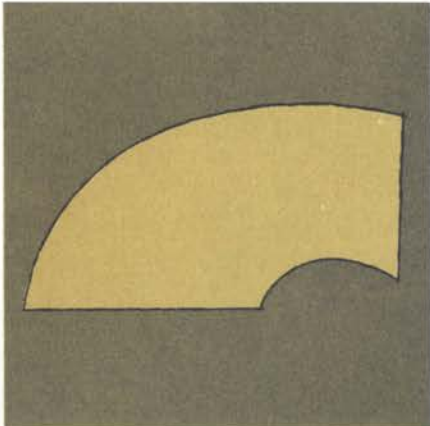

**DUAL SPEED ELECTRIC WIPERS** . . . extra-large 18" overlapping wipers clear middle windshield area for greater all-around visibility. Blades electrically powered and operated at two speeds. (F)

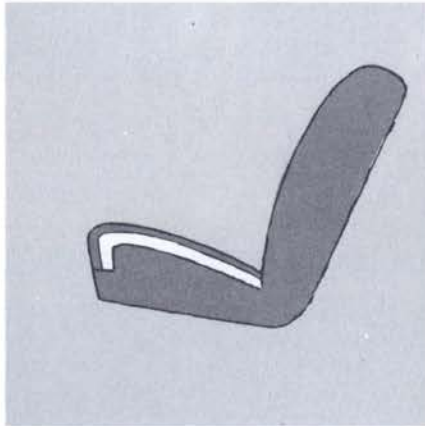

**CUSTOM FOAM CUSHION—Front only** . . . beautifully trimmed, for the ultimate in luxury motoring comfort. Custom lounge 2 1/4" foam pad . . . reduces road shock . . . provides a more relaxing ride wherever you go. (F)



**BACK-UP LAMPS** . . . light up automatically when you shift to reverse, illuminating area behind car. Added safety for driver, pedestrians and other motorists. (FD)



**SUPER DE LUXE RADIO—MANUAL ANTENNA** . . . modernized with fully transistorized chassis that requires no warm-up period. Dial escutcheon and push buttons restyled . . . made by "Delco". (FD)

**ELECTRIC WINDSHIELD WASHERS** . . . a push of a button and two streams of fluid jet on the windshield. Dirt and grime are swept away by windshield wipers. Unit includes new extra-tough plastic jar for fluid. For best results use Pontiac approved solvents. (F)

**HEAVY DUTY AIR CLEANER AND SILENCER** . . . helps assure longer engine life . . . additional protection against dust and dirt particles for intricate parts of your engine. (F)

# LAMP GROUP

**LUGGAGE AND UTILITY LAMP (Sedans and Coupes)** . . . automatic lighting when trunk is lifted . . . permits free use of both hands for loading luggage. Lamp lifts from bracket and has about 17 feet of self-storing extension cord . . . perfect for emergency repairs or tire changes. (UNDERHOOD UTILITY LAMP unit available on Safari.) (FD)



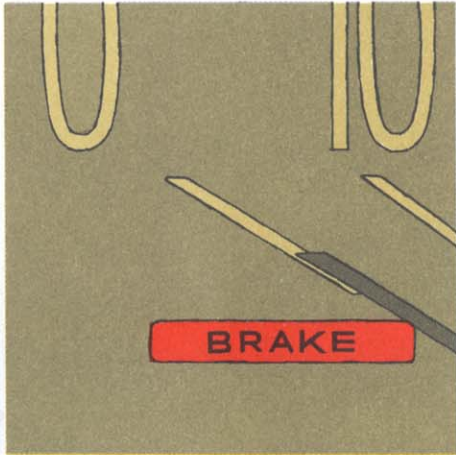

**PARKING BRAKE WARNING LAMP** . . . mounted on lower left side of instrument panel flashes a bright red warning when ignition is turned on and parking brake is set. Light continues on until brake is released. Safeguards brakes by reducing possibility of driving with parking brake partly on. (FD)



**DOMES AND READING LAMP** . . . permits passenger to read or study maps at night without light disturbing driver. Concentrated spot beam is supplied by lamp mounted on interior ceiling. It swings a full 360° for flexible positioning . . . has independent switch. (F)

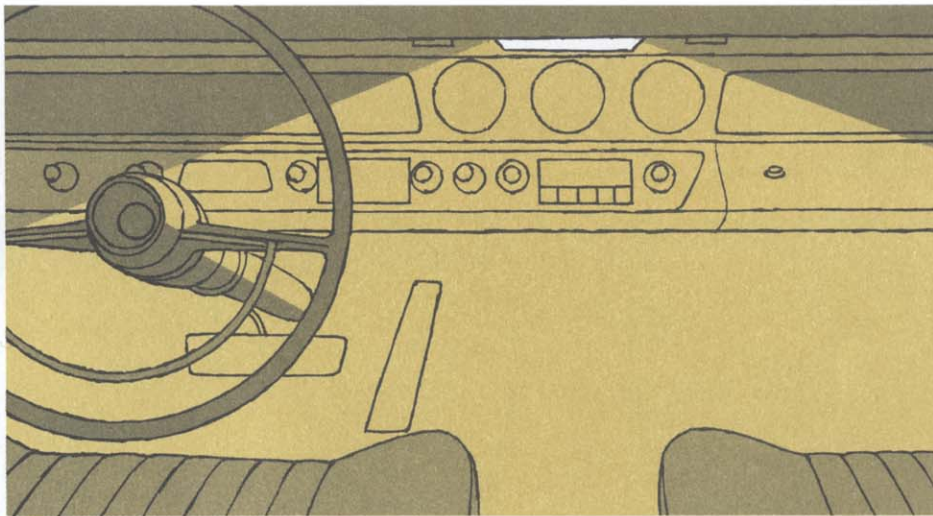

**COURTESY LAMP** (Std. on Catalina Convert., all Bonneville models and Grand Prix) . . . driver and passengers enter and leave the car safely and conveniently at night . . . convenient center location . . . light flashes on when front door is opened. Can be operated manually by switch on instrument panel. (Rear quarter lamps on Catalina Convertible; rear compartment lamp on 9-passenger Safari only.) (FD)

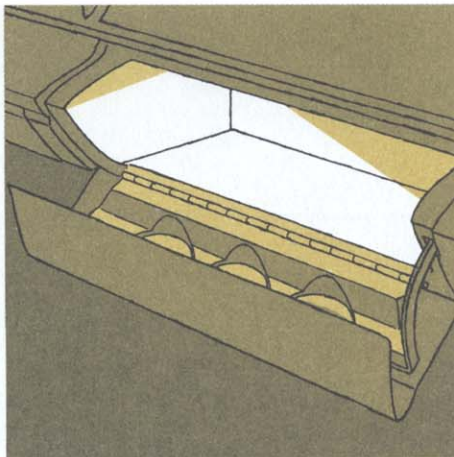

**GLOVE COMPARTMENT LAMP** . . . find what you want in a jiffy. Compartment lights up automatically when door is opened. (FD)

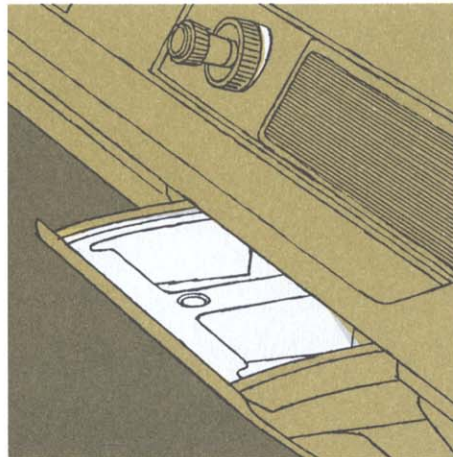

**CIGAR LIGHTER AND ASH TRAY LAMPS** . . . glow automatically when parking lights or headlights go on . . . become visible when ash tray is pulled out . . . when lighter plug is removed. (FD)

# SAFETY GROUP

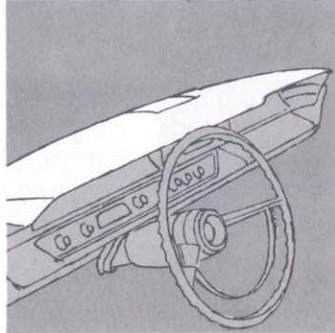
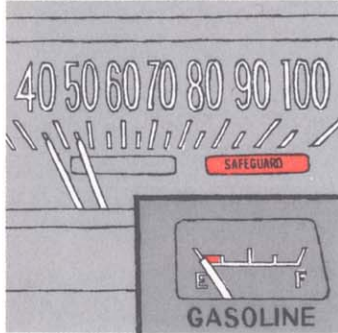

**SAFEGUARD SPEEDOMETER INDICATOR—FUEL LEVEL LAMP** . . . provides warning of excess speed and low fuel. Dial desired speed limit—buzzer sound and amber caution light if speed is exceeded. Red light reminds you to refuel. (D)

**INSTRUMENT PANEL PAD (Std. on Bonneville and Grand Prix)** . . . resilient pad is smartly designed, finished in beautiful, durable Seville grain vinyl to harmonize with interior color scheme. (FD)

**SEAT BELTS** . . . afford added safety on the highway or in traffic. Belts are securely attached to car floor and made of heavy webbing belt fabric with heavy cam-action aluminum buckle. Available in six harmonizing colors. Designed to established specifications. (FD) [Front pair only (F)]



# MIRROR GROUP



**INSIDE NON-GLARE REAR-VIEW MIRROR...** has special finger knob to permit easy adjustment to non-glare or nighttime driving position. (FD)

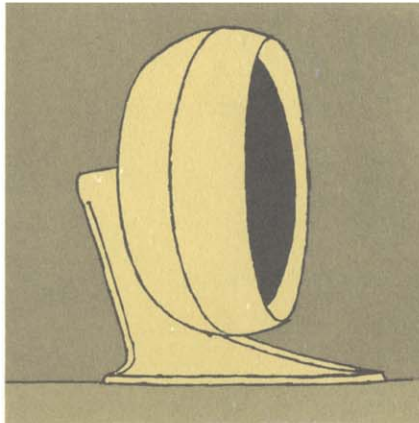

**REMOTE CONTROL MIRROR...** is easily adjusted from inside the car. Sharp styling, front surface chrome plated to guarantee sharp, clear image... no blurring or ghosting with this large, broad-view mirror. (FD)

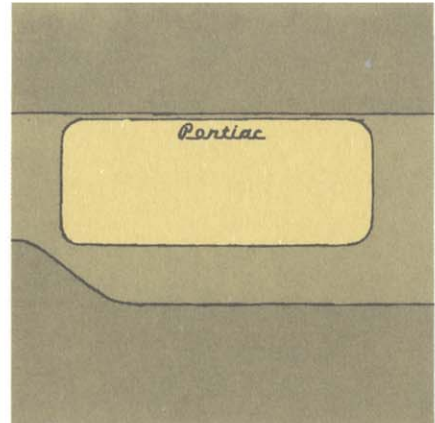

**VISOR VANITY MIRROR...** clips easily to back of visor... ready for use any time. Out of sight when not in use. (FD)

# PROTECTION GROUP

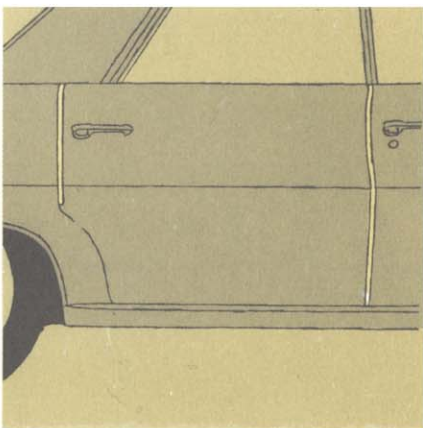

**DOOR-EDGE GUARDS...** gleaming, stainless steel strips that help prevent nicks and scratches on the edge of the door... add beauty to exterior. (FD)

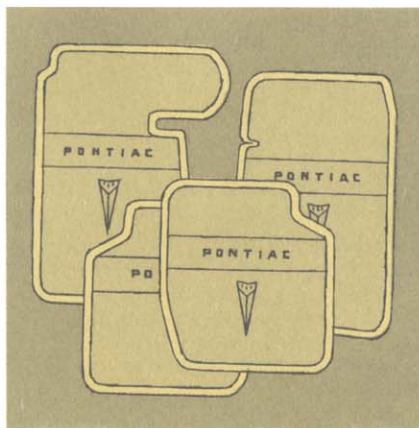

**FLOOR MATS (Front and Rear Compartments)...** help keep car looking like new by protecting carpet... especially during winter and rainy seasons. Easily removed for washing. Available in harmonizing colors. (FD)

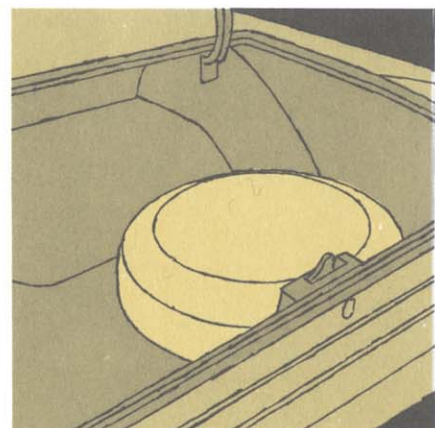

**SPARE TIRE AND WHEEL COVER...** dresses up your luggage compartment... protects luggage from marring and scratching. Slips on and off easily. Standard on Bonneville and Grand Prix, available for all other models except Safari. (FD)

# DECOR GROUP

---

## CATALINA MODELS ONLY

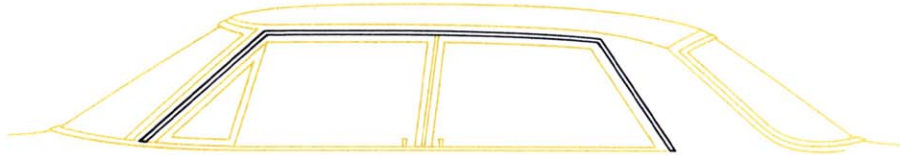

**CATALINA VISTA CUSTOM EXTERIOR TRIM** . . . features bright metal roof drip scalp molding along edge of roof. (F)

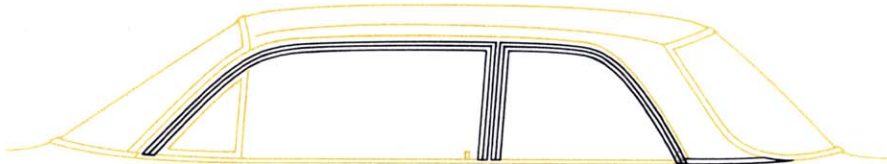

**CATALINA SPORTS SEDAN CUSTOM EXTERIOR TRIM** . . . features bright metal door and rear quarter window frame moldings as well as a rear belt finish molding. (F)

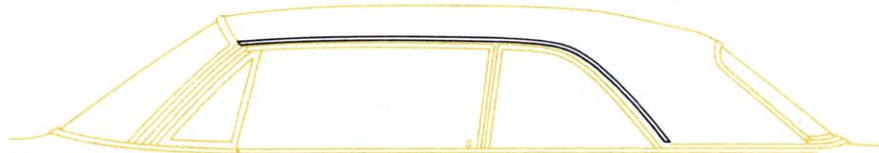

**CATALINA SPORTS COUPE CUSTOM EXTERIOR TRIM** . . . features a bright metal roof drip scalp molding along edge of roof. (F)

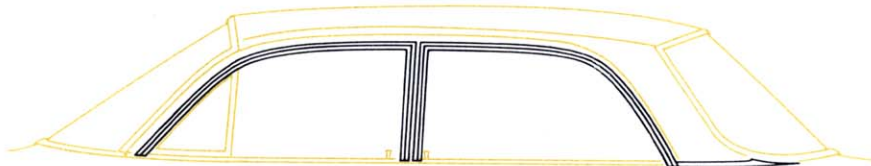

**CATALINA SEDAN CUSTOM EXTERIOR TRIM** . . . features bright metal front and rear door window frame moldings as well as a rear belt finish molding. (F)

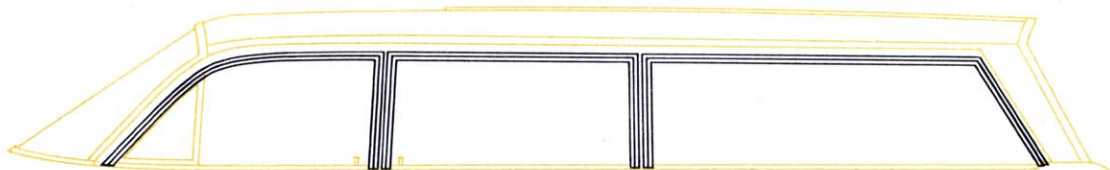

**CATALINA 6- AND 9-PASSENGER SAFARI CUSTOM EXTERIOR TRIM** . . . features bright metal door window frame and rear quarter window frame molding and back window reveal molding. (F)



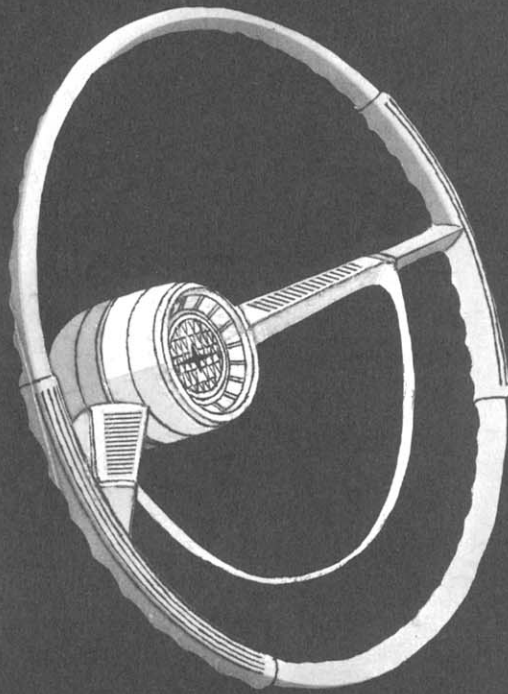

**NEW CUSTOM STEERING WHEEL (Catalina models only)** . . . recessed hub styling with double handgrip sections in metallic pearl plastic, and upper-lower rim in transparent colors over chrome . . . horn ring handy to reach. **(FD)**

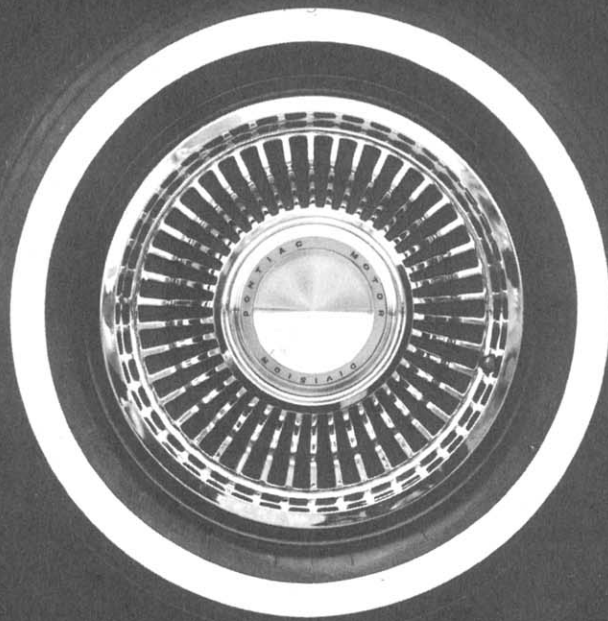

**DE LUXE WHEEL DISCS (Catalina models only)** . . . chrome-flashed stainless steel discs feature deep drawn turbine grooves radially spaced around hub. **(FD)**

# PONTIAC OPTIONS

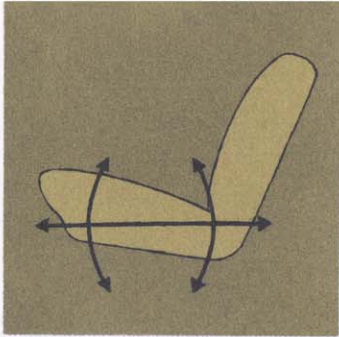

**POWER 6-WAY SEAT** . . . permits wide choice of seat positions. Promotes easier steering, better visibility, safer driving, extra comfort. Available on Std. seat only. **POWER TILT SEAT**—left-hand bucket seat only. (F)

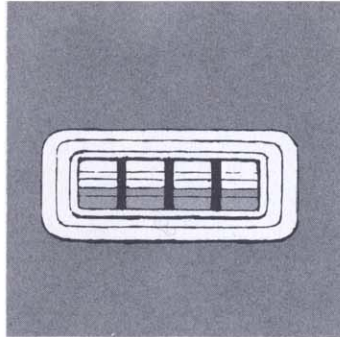

**POWER WINDOW LIFT** . . . automatically operates all vertically moving windows from a single control panel at the driver's side. Individual control buttons near each window. (F)

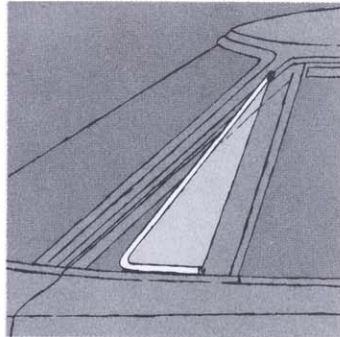

**POWER OPERATED VENT WINDOWS** . . . control side-vent windows at touch of a button . . . free driver from reaching to open right-hand vent window. (Only available with Power Window Lift, and only on Bonneville and Grand Prix.) (F)

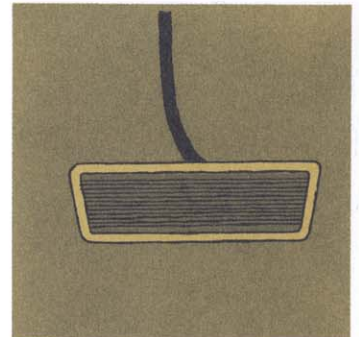

**"WONDER-TOUCH" POWER BRAKES** . . . positive braking and car control with a light touch of the toe. Braking is easier, but "feel" of control is still there . . . quick stops are made with greater assurance. (FD)

**"WONDER-TOUCH" POWER STEERING** . . . drive, shift and park with amazing ease. One to two pounds of effort is sufficient for steering. A good suggestion for greater enjoyment of a new Pontiac. (FD)

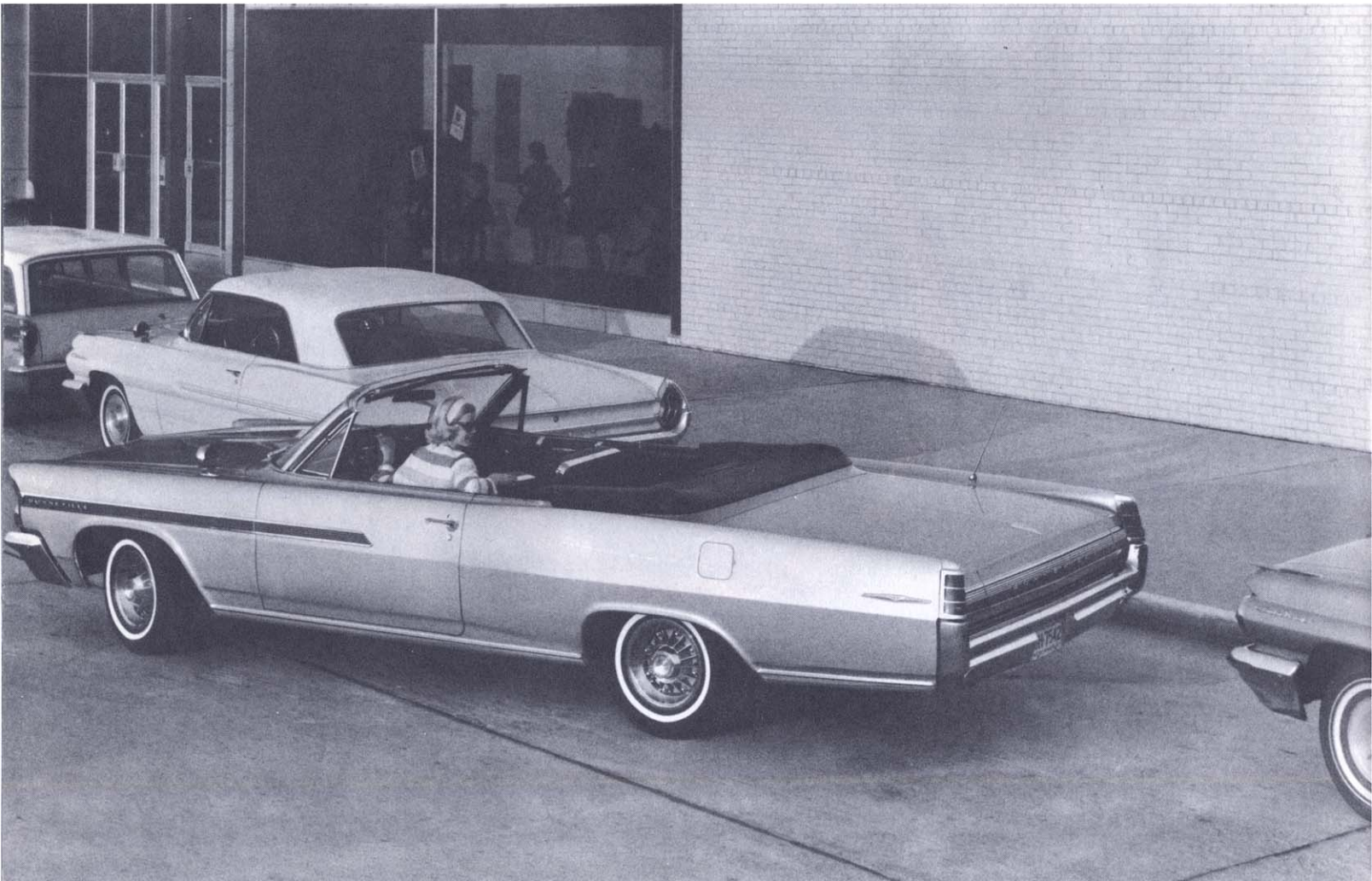

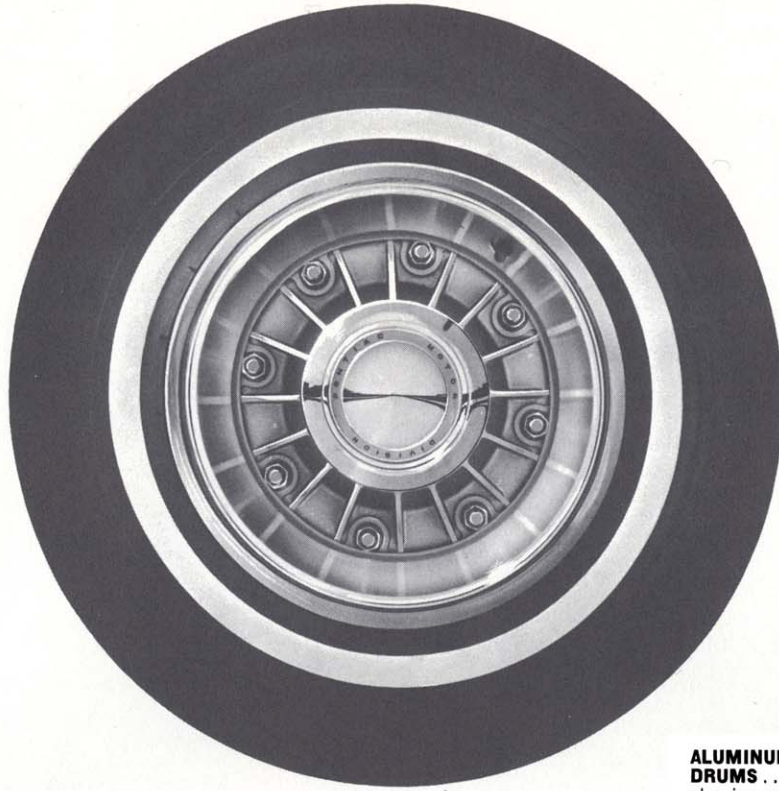

**ALUMINUM WHEEL HUBS AND BRAKE DRUMS** . . . big, 14-inch integrated aluminum wheel face and drum bonded to cast iron braking surface . . . virtually immune to fade. (F)

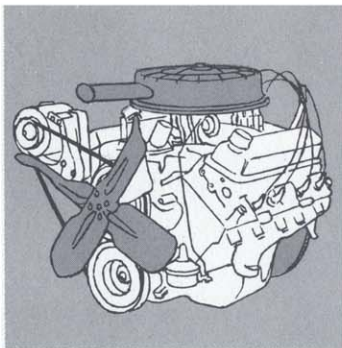

**ENGINE OPTIONS** . . . the 4-barrel carburetor is standard on the Grand Prix and Bonneville and available at extra cost on other models. Tri-Power and Trophy V-8 economy package with Hydra-Matic, also available on all models. Numerous other options. (F)

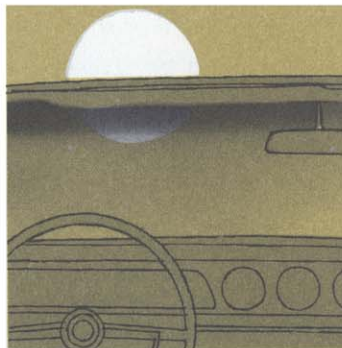

**SOFT-RAY GLASS** . . . fully tinted Safety Plate Glass on all windows with the upper windshield area shaded. Eye-strain, sun and headlight glare are reduced . . . car is cooler. Also available for windshield only. (F)

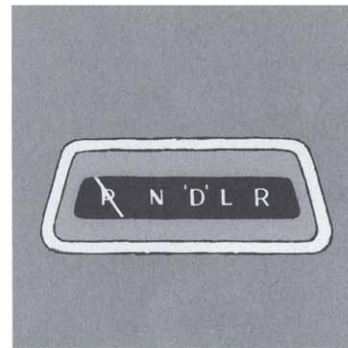

**PONTIAC HYDRA-MATIC** . . . for quieter, smoother shifting. Carefully manufactured for versatile, durable performance and maximum power control under all road and traffic conditions. Available for all engine models. (F)

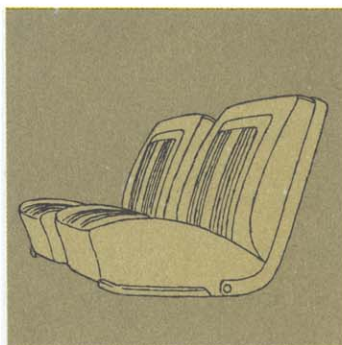

**BUCKET SEATS** . . . trim sophistication and the ultimate in driving pleasure and comfort. A must for the sports-minded individual who wants that extra touch of distinction! (F)

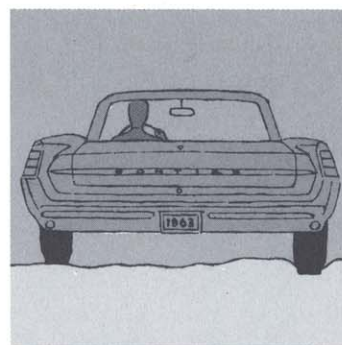

**SAFE-TRACK DIFFERENTIAL** . . . when one rear wheel spins free, additional torque automatically goes to the other wheel. Gets you out of mud and snow, prevents loss of time, gives you better road feel. (F)



**CRUISE CONTROL** . . . automatically adjusts throttle setting to maintain speed you've dialed. A touch of the toe on the brake overrides automatic control. Eliminates foot fatigue on turnpikes. (D)

# PONTIAC INDIVIDUAL ACCESSORIES

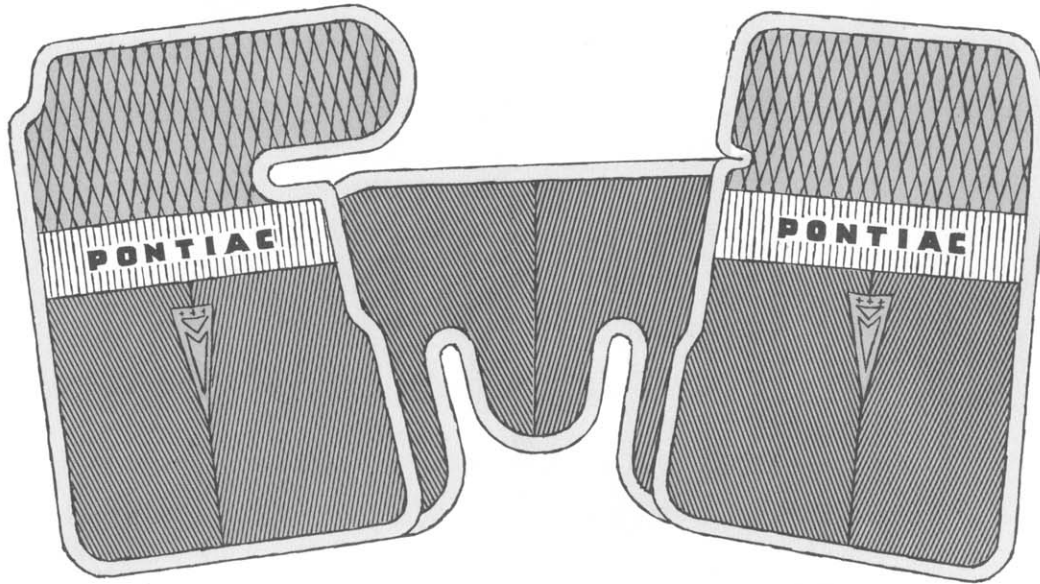

**FULL WIDTH FLOOR MAT (Front only)** . . . especially tailored to fit your new Pontiac. Easily removed for cleaning . . . durable for long wear! Available in 6 colors selected to complement interiors. This top-quality front compartment mat extends over center hump. Attractively styled . . . economically priced. (D)

**TRI-COMFORT CIRC-L-AIRE CONDITIONER** . . . 1963 unit offers an entirely new concept in year around comfort. New unit dries the highly humid air by first cooling it, then warming it to the desired temperature comfort level. Tri-Comfort Circ-L-Aire allows you to drive on the hottest days in draft free comfort with the windows closed . . . reduces dust and pollen in car. Can provide heat only, air conditioning only, or a combination of both. (FD)



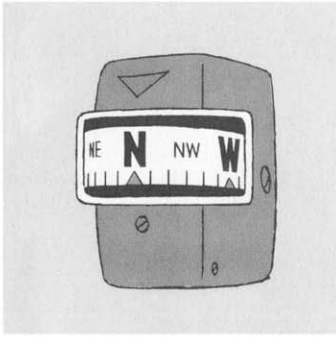

**PONTIAC CAR COMPASS** . . . helps keep you heading in the right direction day or night! Illuminated for night reading when headlamps are on. Mounts on left end of the instrument panel for easy viewing. (D)

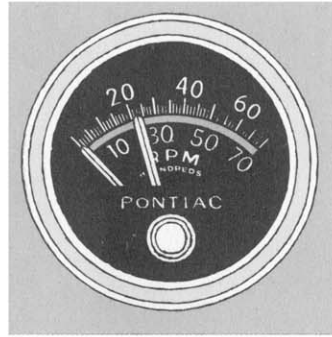

**PONTIAC TACHOMETER** . . . tells you the exact number of engine RPM's and how hard your engine is working at all times. Enables you to maintain optimum driving performance and efficiency. (FD)

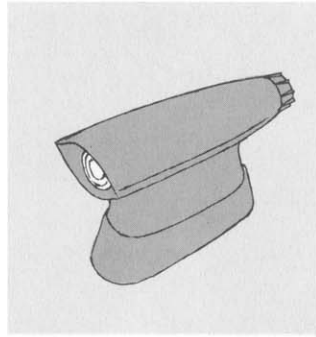

**GUIDE-MATIC HEADLAMP CONTROL** . . . automatically dims or flicks up bright lights when needed. "Safety-Salute" signals oncoming drivers in a courteous but urgent manner. The perfect option for nighttime driving. (D)

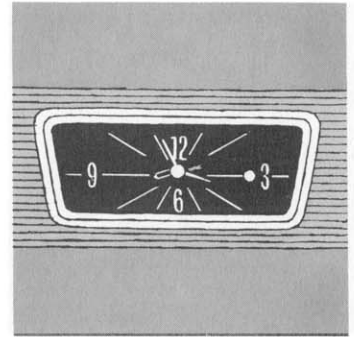

**PONTIAC ELECTRIC CLOCK (Catalina only—except with air conditioning)** . . . features a sweep second hand and special built-in automatic self-regulator. Illuminated dial for easy night reading. (F)

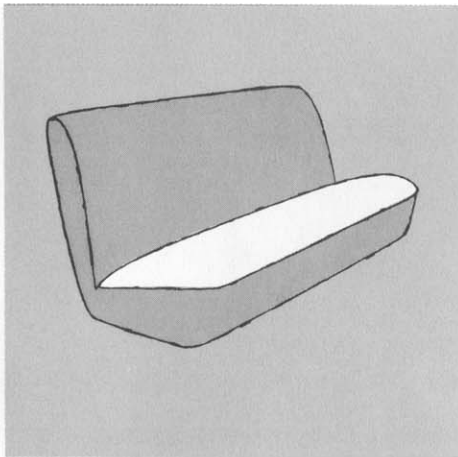

**CUSHION TOPPER** . . . gives extra protection to that much-used seat . . . adds to comfort. Soft foam rubber pad covers entire seat cushion. (D)

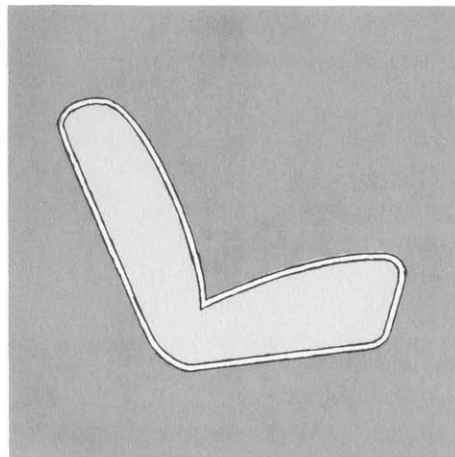

**CLEAR PLASTIC SEAT COVERS** . . . made of heavy gauge long-wearing plastic . . . fashionable, sensible protection for upholstery. They're easy to clean . . . help keep value high! (D)

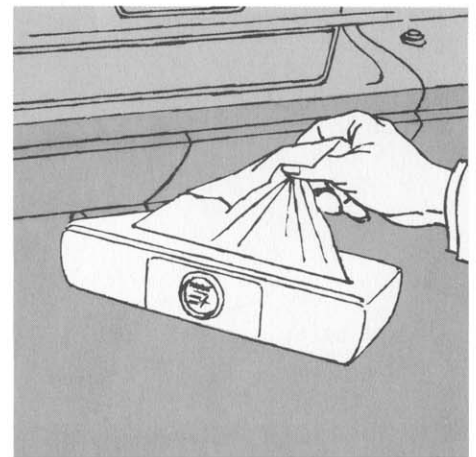

**PONTIAC TISSUE DISPENSER** . . . holds a regular-size Kleenex box! Unit mounts under instrument panel . . . swings out for use . . . swings back when not needed. (D)

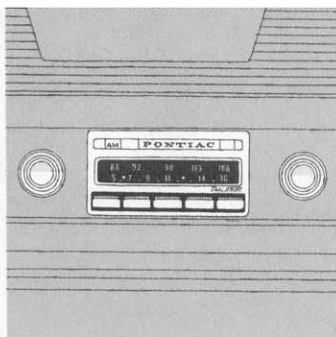

**NEW PONTIAC FM-AM RADIO** . . . offers unlimited listening enjoyment on both FM and AM frequencies. New FM-AM radio is completely transistorized. Push buttons can be set to AM or FM or combination of both. (FD)

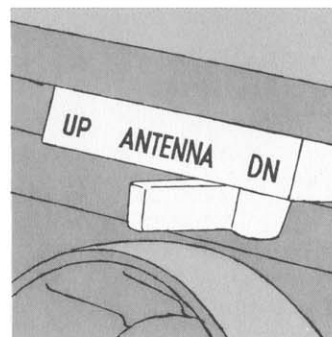

**ELECTRIC POWER ANTENNA** . . . raise or lower as desired by using separate switch on instrument panel. Mounted on right rear fender on all models. Prevents bending and breaking caused by garage doors, low-hanging limbs etc. (FD)

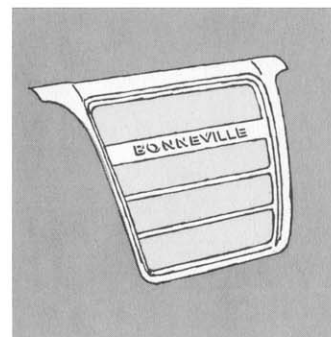

**SEPARA-PHONIC REAR SEAT SPEAKER SYSTEM** . . . the fine quality of stereo-listening in the car. Brilliant tone depth and control. Three-step switch lets you play through front, rear or both speakers. (FD)

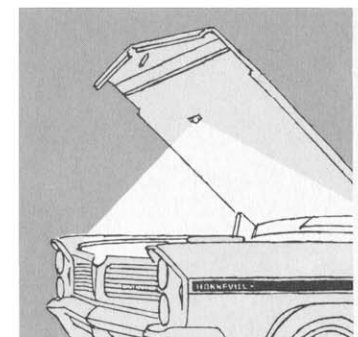

**NEW PONTIAC UNDERHOOD LAMP** . . . floods the entire engine compartment with a powerful glow. Lamp goes on automatically when hood is raised, off when closed. A nice accessory for nighttime minor engine checks. (D)

**NEW VERBRA-PHONIC REAR-SEAT SPEAKER** . . . exciting new listening experience for music-lovers! Plugs into any Pontiac car radio. Delays sound projection from the rear-seat speaker by 25 to 35 thousandths of a second—just enough to simulate the acoustics of a fine concert auditorium. (D)

**VENT SHADES (Sedans and Safari models)** . . . fit snugly over top of the side windows. These handsome, awning-type shades add to the appearance of your car, yet they are very functional, too. They shade driver and passengers from the sun, deflect rain, help keep the car cooler. (D)

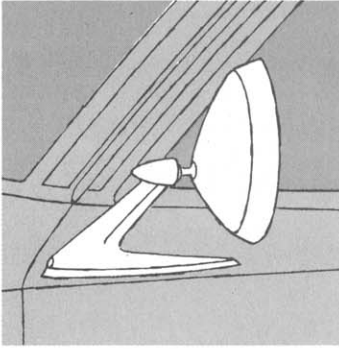

**OUTSIDE REAR-VIEW MIRROR** . . . eliminate "ghosting" and blurring with this mirror. Its chrome reflecting glass gives a sharp, clear view. Smartly styled! Easily adjusted. (FD)

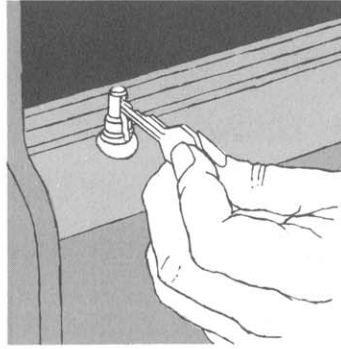

**REAR DOOR SAFETY LOCK** . . . prevents children from opening rear door. Once lock button is pushed down, rear doors cannot be opened without inserting a key into lock button to raise it. (D)

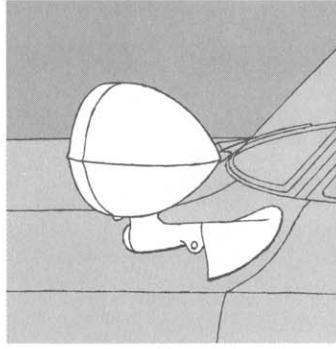

**PONTIAC SPOT LAMP** . . . easily controlled from inside car by just the twist of the handle. Spot lamp is completely chromed for long wearing durability. Great for reading road signs, house numbers, etc. at night. (D)

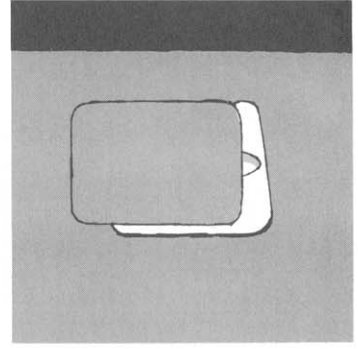

**PONTIAC "NO-MAR" FUEL DOOR GUARD** . . . protects your car from nicks or scratches caused by careless gas station attendants! Made of sturdy stainless steel that won't rust or corrode. Beautifully contoured! Available for all models. (D)

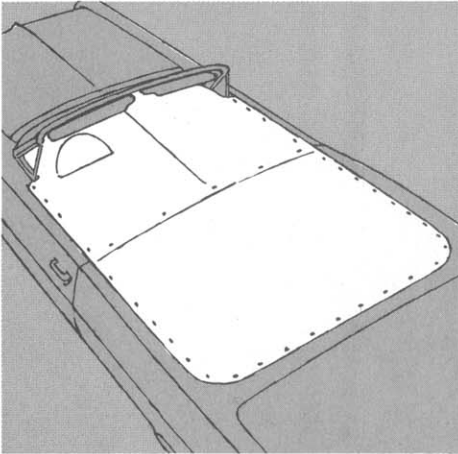

**PONTIAC TONNEAU COVER** . . . helps protect the interior of your Pontiac from dirt, dust, sun and rain. Ideal for daytime parking—keeps seats cool. Sturdy vinyl cover conveniently snaps off or on in a jiffy. Can be left on when driver only is in car. (D)

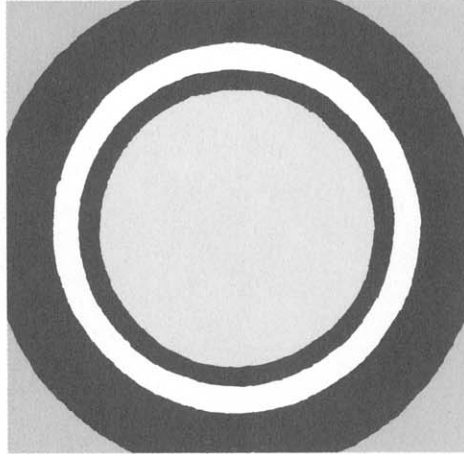

**WHITE SIDEWALL TIRES (Tubeless)** . . . new, narrow band—sportier white sidewall tires give the car extra prestige . . . add greater resale value. (F)

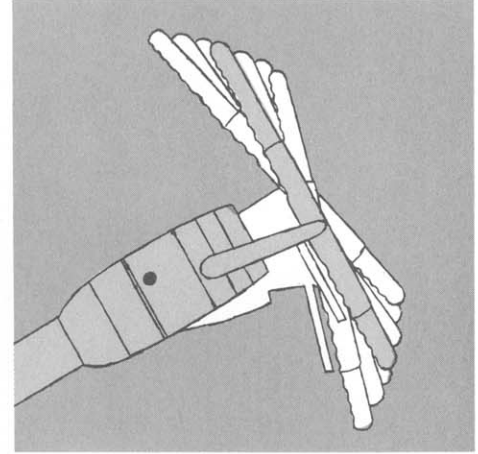

**NEW TILTING STEERING WHEEL** . . . easily adjusts to 7 different positions to meet drivers' individual size and shape. Provides maximum steering comfort and safety, also permits easier entry and exit from car. (F)

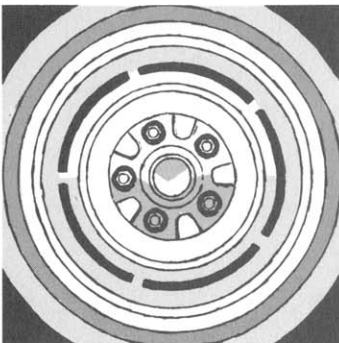

**SPORTS WHEEL COVER** . . . a Pontiac first! Adds dash, distinction, and a striking new appearance to your Pontiac. Wheel covers are made of impressive chrome flashed stainless steel and fit neatly over rims. (FD)

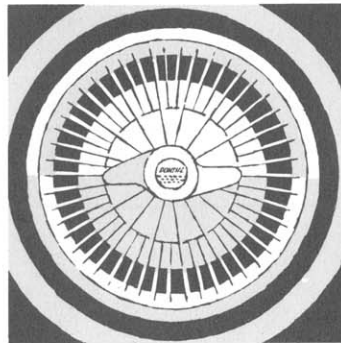

**WIRE WHEEL DISCS** . . . for the man who wants a special flair and a sports car look. Elegant, gleaming wire spokes are boldly styled and strong. They add up to a luxurious personal touch that's all your own. (D)

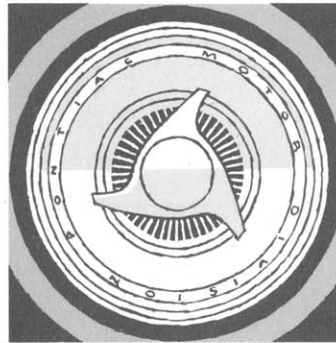

**CUSTOM WHEEL DISCS** . . . give your Pontiac the well-dressed look. Made of chrome-flashed stainless steel, with a three prong die-cast spinner on the outer surface of the hub. (FD)

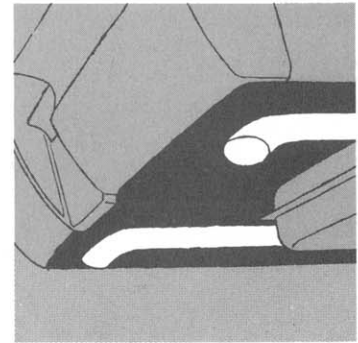

**DUAL EXHAUSTS** . . . available on all models! Cut down back pressure in the exhaust system adding to efficiency. Standard on Grand Prix. (FD)

**GAS CAP LOCK** . . . prevents theft of gasoline and damage to tank by prankish children. Can be installed in a few minutes with lock coded to separate key. If you've "lost" your gasoline—you'll know what a wonderful item this is. (D)

**REMOTE CONTROL TRUNK LID RELEASE (Except Safari)** . . . lets you open trunk from passenger compartment without removing key from ignition. Pull-type control is located on right-hand side wall of glove box. Trunk may also be opened by key if so desired. Wonderful for pick-up service stops, hotels, supermarkets, etc. (FD)

# PONTIAC SAFARI

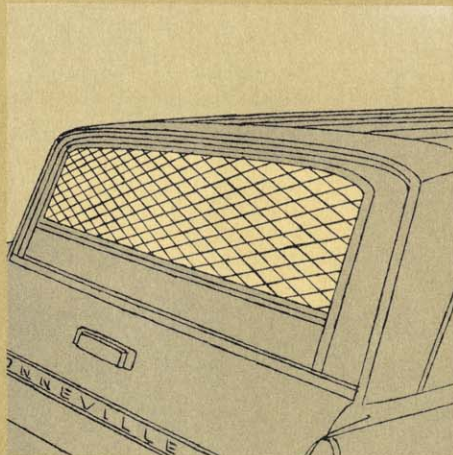

**TAILGATE WINDOW SCREEN** . . . allows you to drive with tailgate window open for added air circulation . . . keeps out bugs when camping. Screen is made of fine reinforced mesh . . . fits neatly into glass run channel . . . held in place by raising window part way. Screen must be removed to close window. **(D)**

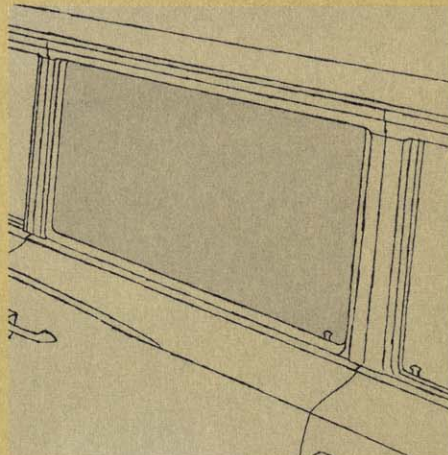

**REAR DOOR WINDOW SCREENS** . . . are great for campers or motorists transporting children or pets. Made of heavy gauge, long-wearing aluminum. They attach permanently to inner rear door window frames. Door window glass may be raised or lowered without removing screen. Sold in pairs. **(D)**

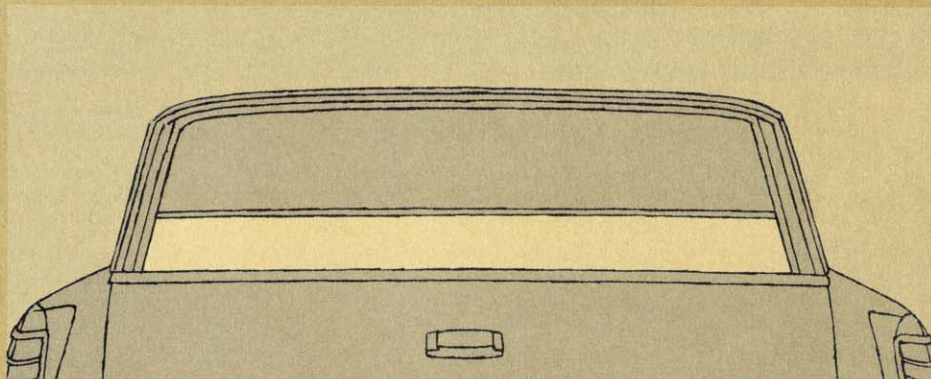

**POWER TAILGATE WINDOW (Safari)** . . . conveniently located switch lets you raise or lower tailgate window with the touch of a finger . . . makes it easy to open tailgate, too. Standard on Pontiac 9-passenger Safari. **(F)**

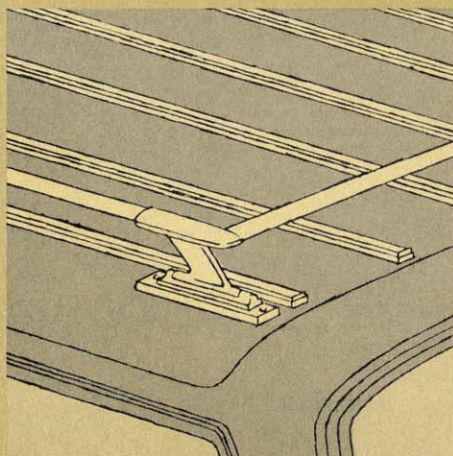

**CHROME LUGGAGE CARRIER** . . . is handsome and sturdy—made for the outdoorsman or vacationer. Carries a lot of luggage, thus allows plenty of extra passenger space inside. Handy side rails provide perfect tie-down spot for tarps, luggage, etc. Available for all Safari models. **(FD)**

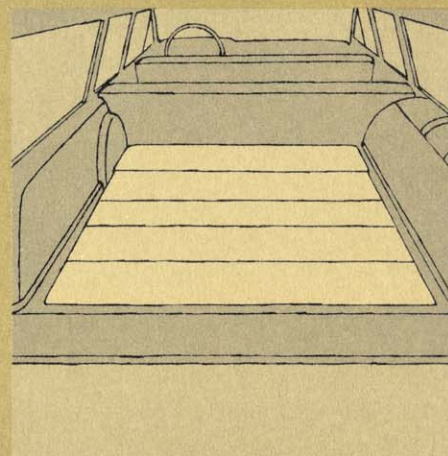

**REAR LOAD AREA PAD** . . . an ideal item for those trips with children—doubles as mattress or beach pad . . . makes it more comfortable in the load area for the kids. Pad is of durable coated fabric . . . resilient construction. Available in two-tone combinations of gray and aqua or mahogany and red. **(D)**

# '63 Tempest Accessories

Enjoy extra driving pleasure and save valuable time by having your accessories put on your car during assembly. Many of the most popular engineer-approved Tempest accessories have been placed in groups for your ordering convenience. All of the following groups are factory installed.

## **TEMPEST BASIC GROUP**

Dual Speed Electric Wipers  
Foam Cushion Seat (Front only)  
Tempest Back-Up Lamps  
Push Button Radio—Manual Antenna  
Tempest Oil Filter (L-4 Engine only)  
Heavy Duty Air Cleaner  
Tempest Windshield Washers

## **SAFETY GROUP**

Tempest Seat Belts (Front Pair)  
Instrument Panel Cushion  
Bumper Guards (Front and Rear)  
Tempest Dual Horns

## **MIRROR GROUP**

Inside Non-Glare Rear-View Mirror  
Remote Control Mirror  
Visor Vanity Mirror

## **CUSTOM INTERIOR GROUP**

De Luxe Steering Wheel  
Right-Hand Sunshade  
Cigar Lighter  
Custom Interior Trim

## **EXTERIOR UPPER DECOR GROUP**

Windshield Molding and  
Rear Window Molding  
Upper Exterior Door and Window Molding

## **EXTERIOR LOWER DECOR GROUP**

Front Fender Side Molding  
Front Fender Top Ornaments  
Rocker Panel Molding  
Rear End Panel Molding

## **TEMPEST OPTIONS**

Tempest Power Steering  
Tempest Power Tailgate Window (Safari)  
Soft-Ray Glass  
Tempest Automatic Transmission  
V-8 Engine  
4-Speed Manual Transmission

## **TEMPEST INDIVIDUAL ACCESSORIES**

Tempest Floor Mats  
Wire Wheel Discs  
Custom Steering Wheel  
New Custom Circ-L-Aire Conditioner  
Outside Rear-View Mirror  
Parking Brake Teletale  
Tempest Rally Clock  
Tempest Glove Compartment Lamp  
Tempest De Luxe Wheel Discs  
Custom Wheel Discs  
Spare Tire Cover  
White Sidewall Tires (Tubeless)  
Luggage Carrier (Safari)  
Tempest Door-Edge Guards  
Gas Cap Lock  
Tempest Trunk Light  
Tempest Tachometer  
Tempest Console  
Ash Tray Lamp  
Tempest Spot Lamp  
Courtesy Lamp  
New Tempest Underhood Lamp  
New Tonneau Cover

**(F)** FACTORY INSTALLED  
**(D)** DEALER INSTALLED  
**(FD)** FACTORY OR DEALER INSTALLED

**NOTE:** All accessories featured as part of a group may be purchased as individual factory installed items if desired, with the exception of the Custom Interior Trim and all exterior decor items.



# TEMPEST BASIC GROUP

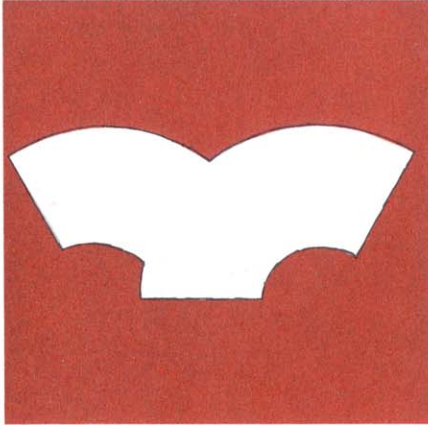

**DUAL SPEED ELECTRIC WIPERS**... newly designed motor operates both fast or medium speed and gives you really consistent wiper action. Features new tandem action. (FD)

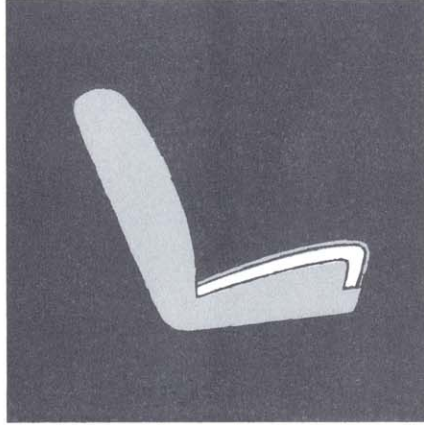

**FOAM CUSHION SEAT (Front only)**... affords you the ultimate in driving, riding comfort. Custom lounge 1 $\frac{3}{4}$ " foam cushion floats you over the bumps... reduces annoying road shock... lets you enjoy your new Tempest more. (F)

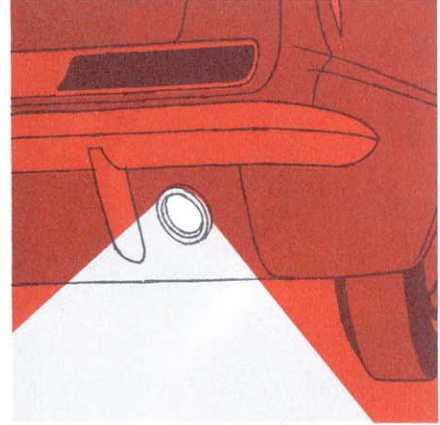

**TEMPEST BACK-UP LAMPS**... light up automatically as you shift into reverse. Illuminate area behind car to make backing up at night much easier, safer... warns pedestrians and other cars of your intention. Located below rear bumper. (FD)

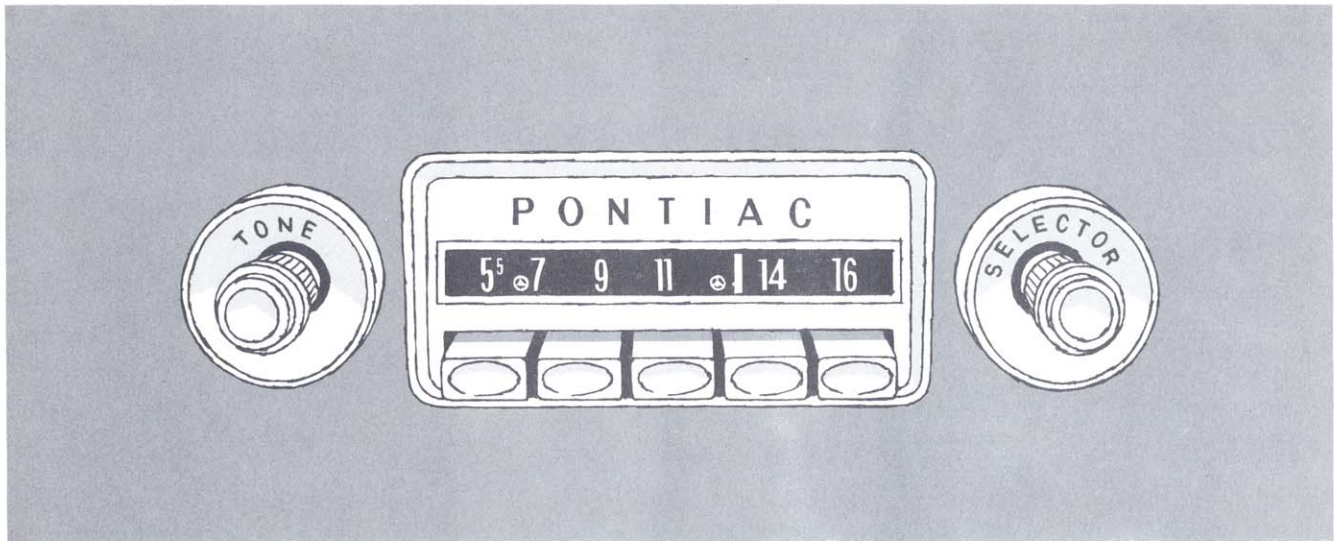

**PUSH BUTTON RADIO—MANUAL ANTENNA**... to bring you excellent listening enjoyment. Push button type tuning radio-with 57-inch stretch antenna mounted on right front fender. (FD)

**TEMPEST OIL FILTER**... keeps dirt and other foreign matter from engine for top efficiency. When filter unit needs replacement entire unit is replaced. (L-4 Engine only.) (F)

**HEAVY DUTY AIR CLEANER**... additional help in protecting vital parts of your engine from harmful dust and dirt particles. A real safeguard for better, longer engine life. (F)

**TEMPEST WINDSHIELD WASHERS**... just push a button on the wiper control and two streams of fluid are sprayed over windshield to loosen dirt and grime which is swept away by windshield wipers. (FD)

# SAFETY GROUP

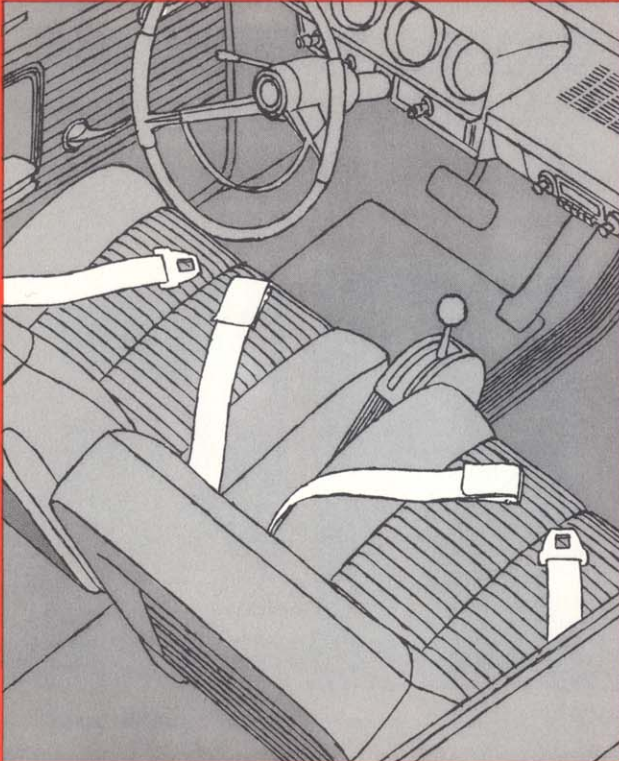

**TEMPEST SEAT BELTS**... feature easy-to-snap-on cam-action aluminum buckle and heavy webbing belt fabric. Available in six harmonizing colors. Designed to meet established specifications. **(F)**

**TEMPEST DUAL HORNS**... to produce a more powerful and penetrating signal. A special mellow-tone horn is combined with your Tempest's standard horn. **(FD)**

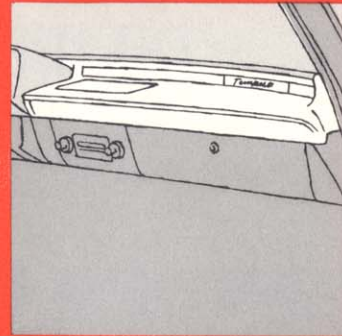

**INSTRUMENT PANEL CUSHION**... new design, new styling... in beautiful, durable Morrokide to harmonize with interior. Pad is cushioned with resilient, long-lasting foam. **(D)**

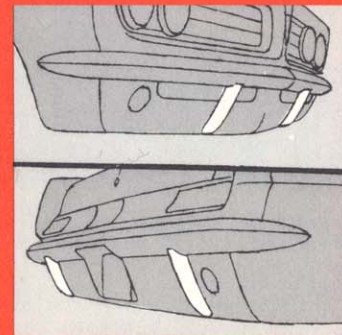

**BUMPER GUARDS (Front and rear)**... can be easily installed on your Tempest model... attached directly below bumper, flank license plate area. Afford extra protection for both front and rear. **(FD)**

# MIRROR GROUP



**INSIDE NON-GLARE REAR-VIEW MIRROR**... has special finger tab to permit easy adjustment to non-glare or nighttime driving position. Mirror position indicated by tab. **(FD)**

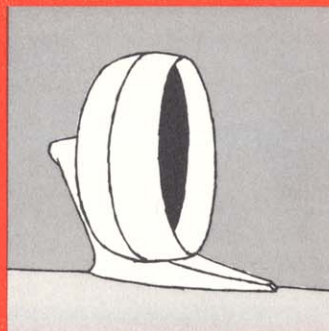

**REMOTE CONTROL MIRROR**... controlled from inside the car—especially appreciated when more than one person drives the same car. Simple control knob lets you make any adjustment desired. Clear, sharp reflection, no blurring or ghosting.

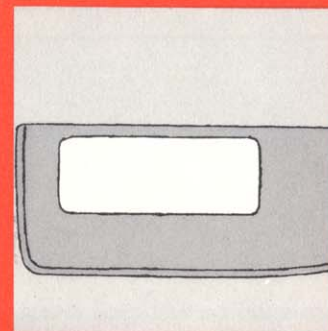

**VISOR VANITY MIRROR**... a greatly appreciated item in any car—clips neatly on to back of visor. Ideal for milady checking make-up, for men combing hair or shaving. **(D)**

# CUSTOM INTERIOR GROUP

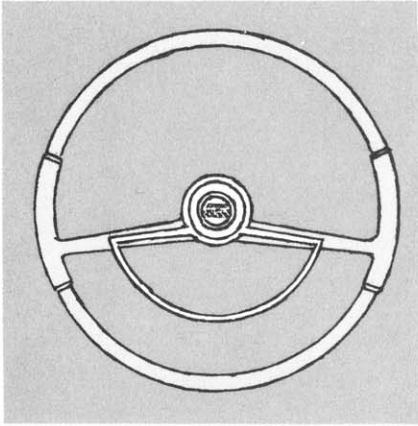

**DE LUXE STEERING WHEEL** . . . available in colors, a complementary shade for each custom interior. Horn ring is easy to reach, beautifully styled, and features 1963 Pontiac crest. (F)

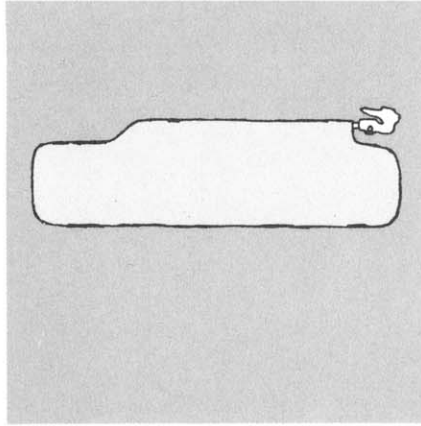

**RIGHT-HAND SUNSHADE** . . . affords front seat passengers added protection from sun rays or bright oncoming headlights. Swings a full 90 degrees for both front and side use. (F)

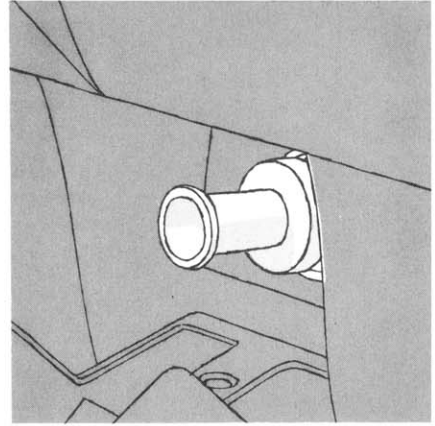

**CIGAR LIGHTER** . . . with automatic "snap-out" action! Lighting element guarded by protective shield to help prevent hot ashes from falling on clothing or upholstery. (FD)

PLUS STUNNING NEW CUSTOM INTERIOR APPOINTMENTS . . . to give your Tempest interior a beautiful appearance. In addition to the other items illustrated in the Custom Interior Group, you'll receive a beautiful Jeweltone Morrokide trim . . . color-keyed loop pile carpeting, full floor door-to-door . . . vinyl coated fabric headlining . . . rear door armrests with integral ash trays . . . front door jamb dome lamp switches . . . coat hook.



# EXTERIOR UPPER DECOR GROUP

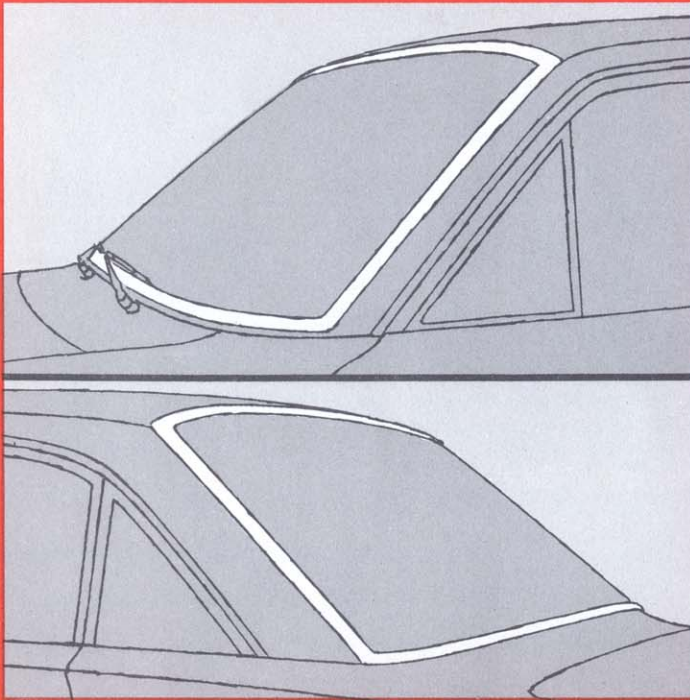

**WINDSHIELD MOLDING AND REAR WINDOW MOLDING**... adds a smart, all-dressed-up look... adds to the sharp appearance of the Tempest. **(F)**

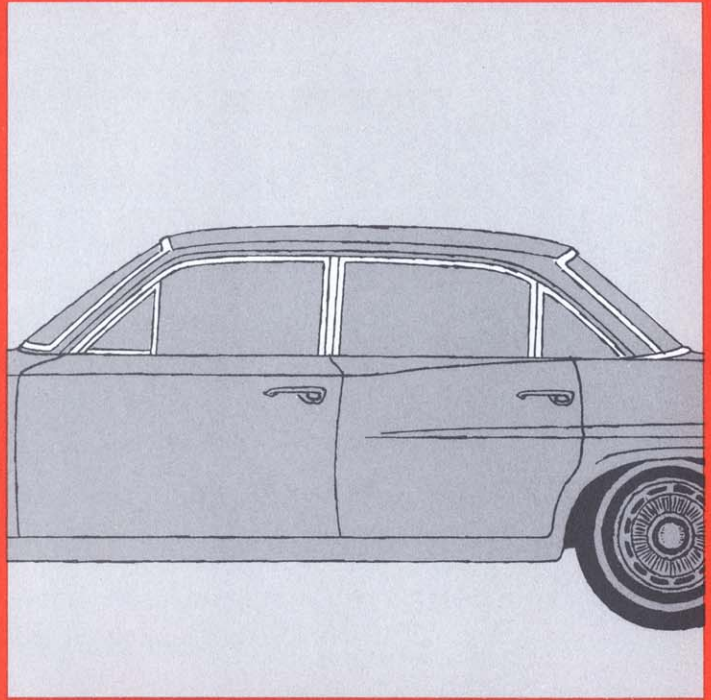

**UPPER EXTERIOR DOOR AND WINDOW MOLDING**... available only as part of this group... gives you that "hard-top" look you're sure to appreciate. **(F)**

# EXTERIOR LOWER DECOR GROUP

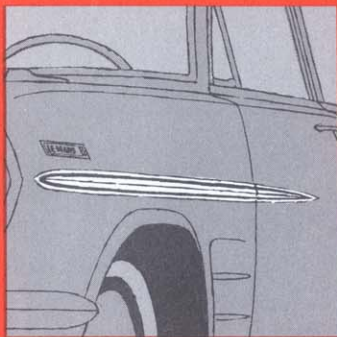

**FRONT FENDER SIDE MOLDING**... sleek distinction and elegance. Moldings run from headlamp to middle of door for extra protection and sparkle. Emphasizes the overall length of your Tempest. **(F)**

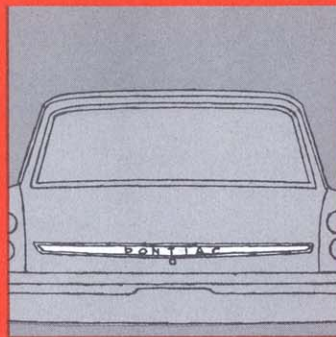

**REAR END PANEL MOLDING**... for that extra touch of elegance. Rear end panel molding highlights the Pontiac name plate. **(F)**

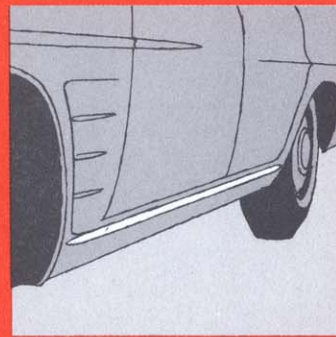

**ROCKER PANEL MOLDING**... beautifies the lower part of the body with bright metal molding. An added touch of elegance that really enhances your Tempest. **(F)**

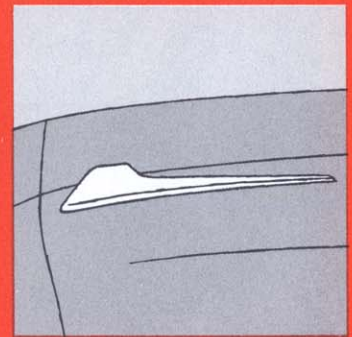

**FRONT FENDER TOP ORNAMENTS**... handsomely styled chrome spears accentuate the long, low, flowing fender lines. **(F)**

# TEMPEST OPTIONS

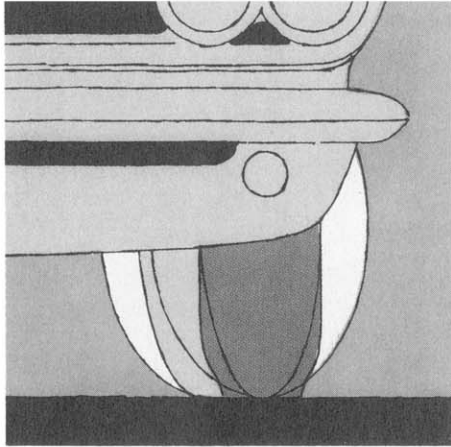

**TEMPEST POWER STEERING** ... linkage booster type—makes driving, steering, parking even easier. This wonderful low cost power steering unit is especially appreciated by the ladies. (FD)

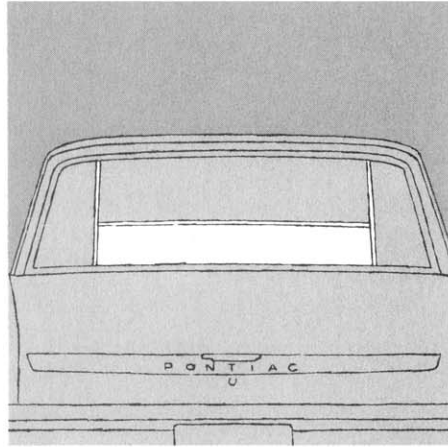

**TEMPEST POWER TAILGATE WINDOW (Safari)** ... lets you raise or lower tailgate window by a simple touch of a finger. Control switch located within easy reach on lower left side of instrument panel. Permits greater circulation of air. (F)

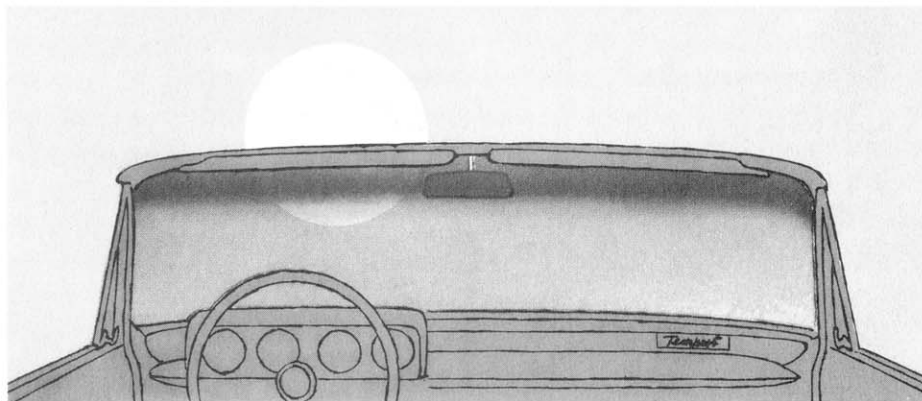

**SOFT-RAY GLASS (All windows)** ... fully tinted Safety Plate Glass with upper area of windshield shaded—reduces eyestrain. Also available for windshield only. (F)

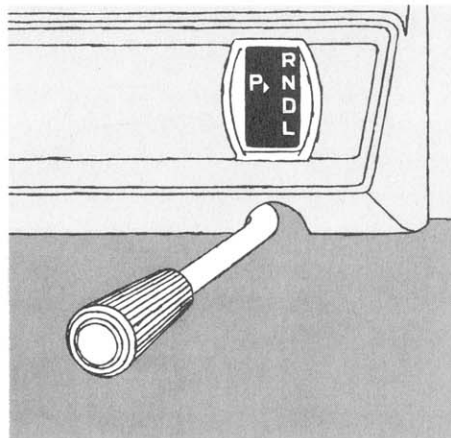

**TEMPEST AUTOMATIC TRANSMISSION** ... re-designed for greater durability and efficiency. Located at rear with engine in front! Unit is an air-cooled, 3-element torque converter, two-speed planetary transmission with automatic upshift. Features five selector positions: Reverse, Neutral, Drive, Low, and Park. For utmost driving pleasure, insist on Tempest Automatic Transmission. (F)

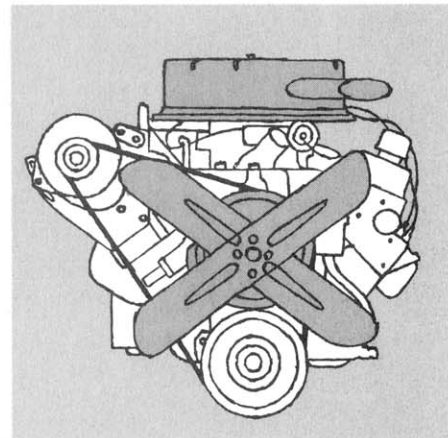

**V-8 ENGINE (Optional)** ... for V-8 power and performance. Features an alloy cast iron block, overhead valves, 326-cubic-inch displacement—260 horsepower! Best of all—wonderful gas-saving mileage, too! Also available is special 4-barrel powerpack option for the L-4 engine—ups horsepower to 166! Both options available with automatic transmission. (F)

**4-SPEED MANUAL TRANSMISSION** ... optional with all 4-cyl. engines, gives sports-car-type performance. Synchronesh in all 4 speeds for smooth shifting up or down. Floor-mounted shift lever. (F)

# TEMPEST INDIVIDUAL ACCESSORIES

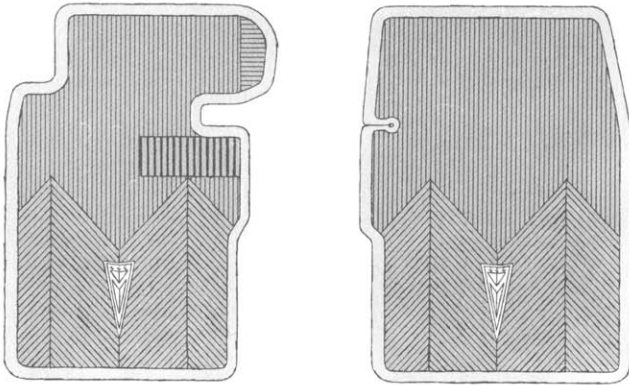

**TEMPEST FLOOR MATS** . . . protect your car's floor covering against unusual wear . . . help keep interior looking like new. Especially useful during bad weather months. (D)

**WIRE WHEEL DISCS** . . . give your Tempest a sports car look. Wire wheel discs are boldly styled, strong, and elegant. A "must" for the sports-minded driver. (D)

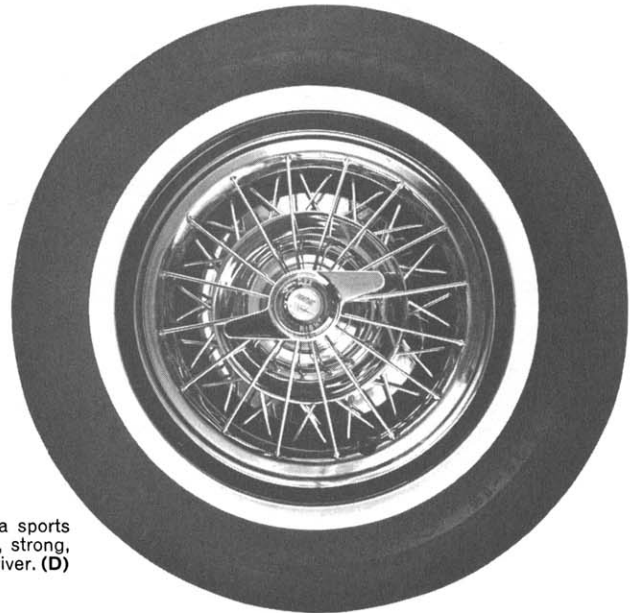

**NEW TEMPEST CUSTOM CIRC-L-AIRE CONDITIONER** . . . year around comfort to keep you fresh and comfortable at all times. Unit is custom designed for your Tempest and provides unobstructed leg room area. Center outlet plus rotary ball-type outlet under each end of instrument panel for excellent distribution and control of cold air flow. (FD)

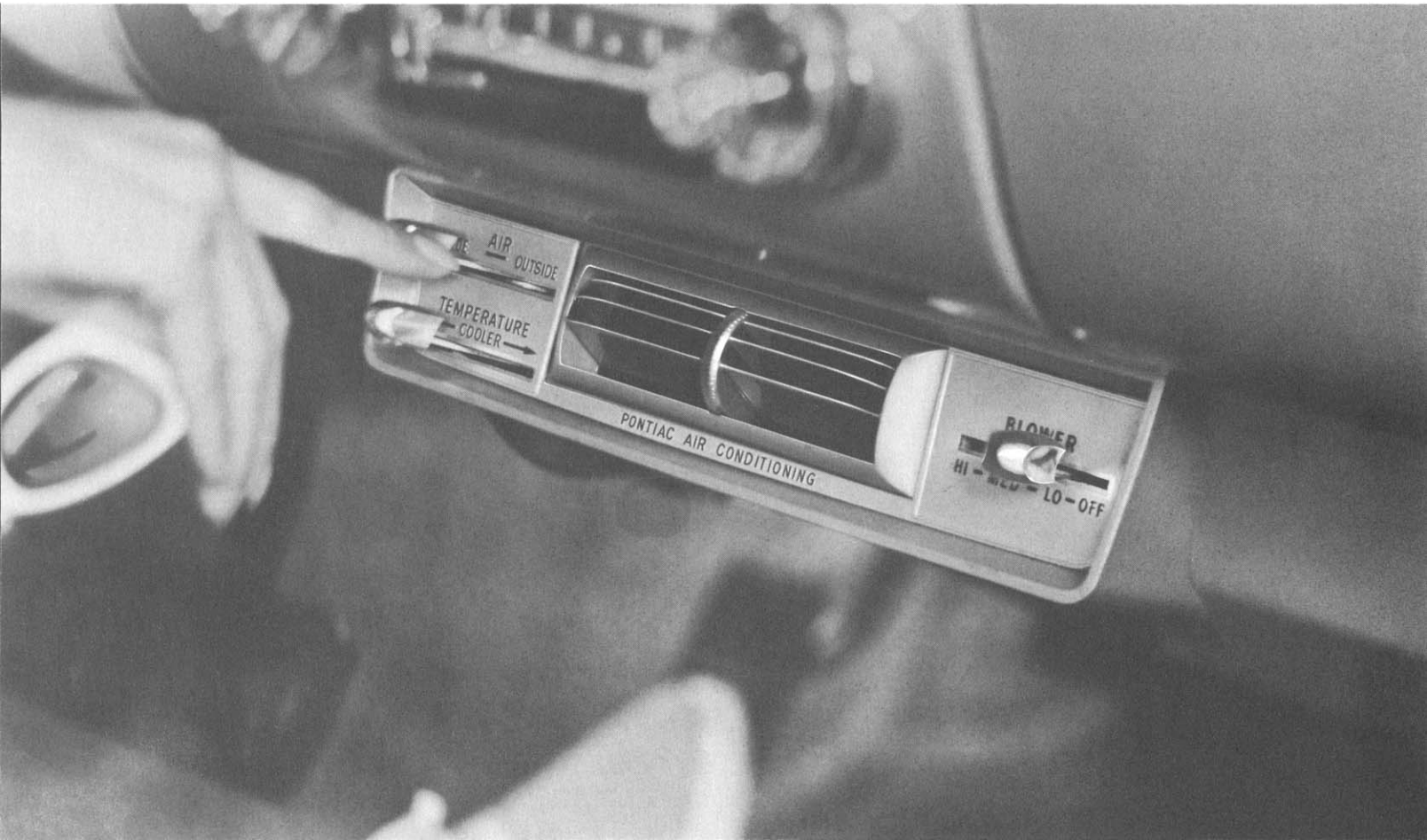

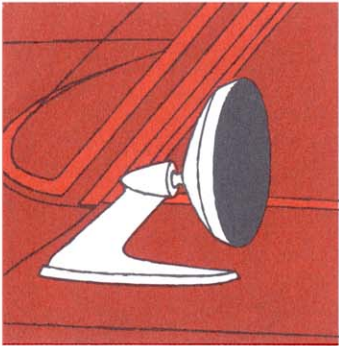

**OUTSIDE REAR-VIEW MIRROR** . . . modernistically styled for the Tempest. Chrome reflecting glass gives sharp, clear picture without "ghosting" or "blurring". (FD)

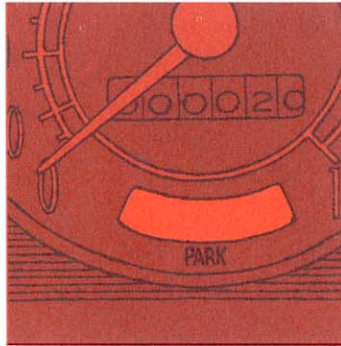

**PARKING BRAKE TELETALE** . . . located in instrument panel. Lights when ignition is on to let you know brake is set! When parking brake is fully released Teletale automatically turns off. (F)

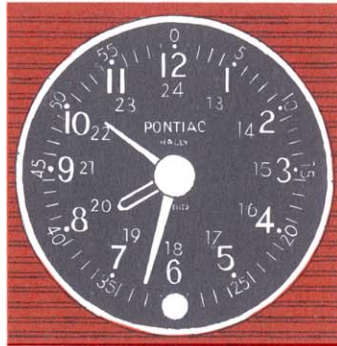

**TEMPEST RALLY CLOCK** . . . smartly styled, features sweep second hand, built-in self-regulator and illuminated dial. (Note: If tachometer is installed, clock is installed on instrument panel shelf.) (FD)

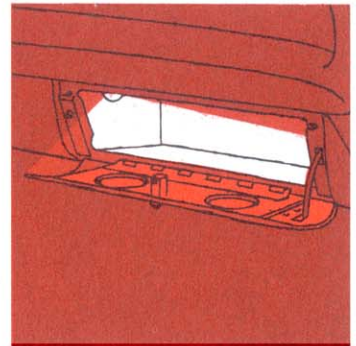

**TEMPEST GLOVE COMPARTMENT LAMP** . . . lights automatically to help you find any item quickly and easily. Brightens entire area, and lamp shuts off automatically when door is closed. (FD)



**TEMPEST TRUNK LIGHT** . . . automatically turns on when trunk lid is lifted! Metal shade directs light to every area of trunk . . . frees hands for loading, unloading luggage, etc. (FD)

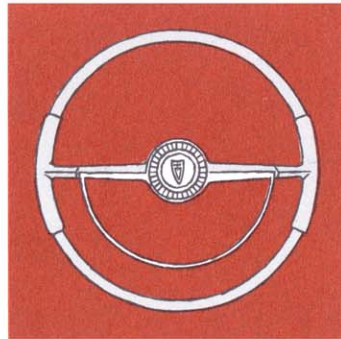

**TEMPEST CUSTOM STEERING WHEEL** . . . attractive metallic pearl plastic with double handgrip sections. Upper-lower rims are in transparent colors over chrome. Horn ring is handy to reach. (F)

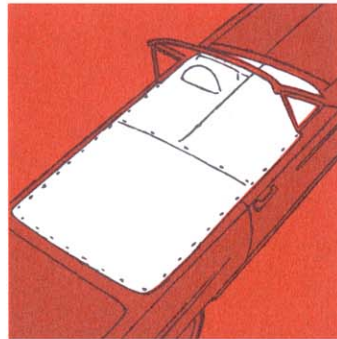

**TEMPEST TONNEAU COVER** . . . helps protect the interior of your Tempest from dirt, dust, sun and rain. Ideal for daytime parking—keeps seats cool. Sturdy vinyl cover conveniently snaps off or on in a jiffy. Can be left on when driver only is in car. (D)

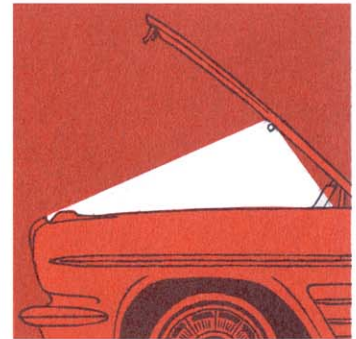

**NEW TEMPEST UNDERHOOD LAMP** . . . automatically floods the entire engine compartment with a powerful glow when hood is raised—off automatically when hood is closed. A nice accessory for nighttime minor engine checks. (D)

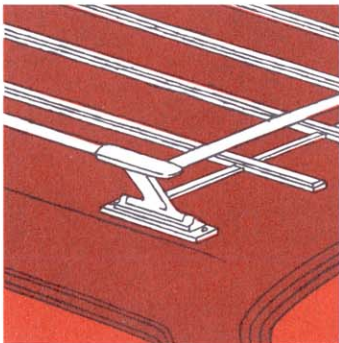

**LUGGAGE CARRIER (Safari)** . . . available for your Tempest Safari station wagon. Ideal for carrying large amounts of cargo, wonderful for the traveling family or outdoorsman! (FD)

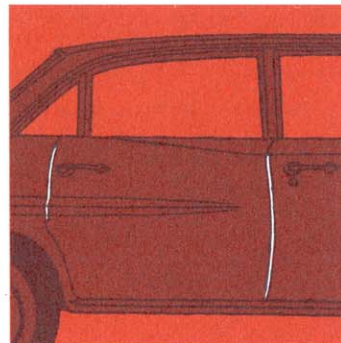

**TEMPEST DOOR-EDGE GUARDS** . . . add real elegance and an extra measure of protection to your new Tempest's exterior. Help prevent nicks and scratches on the edges of the doors. (D)

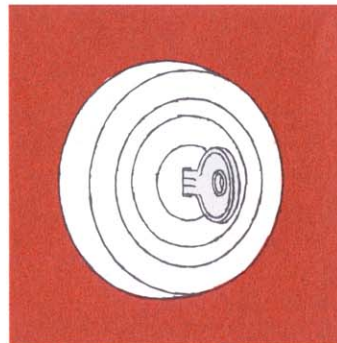

**GAS CAP LOCK** . . . helps prevent fuel theft and possible damage to fuel system by youngsters' pranks. Lock on gas cap is coded to separate key. (D)

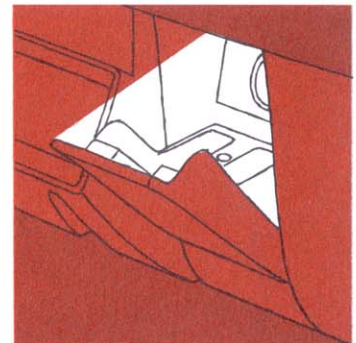

**ASH TRAY LAMP** . . . real convenience with a diffused glow which appears automatically when parking lights or headlights go on . . . visible when ash tray is pulled out. (F)



**TEMPEST DE LUXE WHEEL DISCS** . . . add a striking new appearance to your car. These handsome stainless steel discs ensure best appearance over long period of time. (FD)

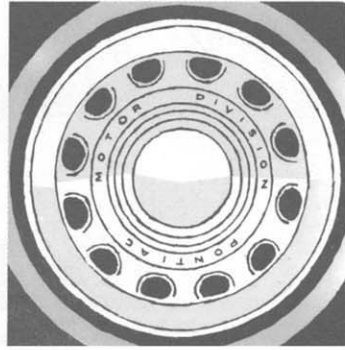

**TEMPEST CUSTOM WHEEL DISCS** . . . plush, sparkling prestige for your Tempest. Discs are bright chrome-flashed stainless steel with 12 oval-shaped holes. For that modern touch! (FD)

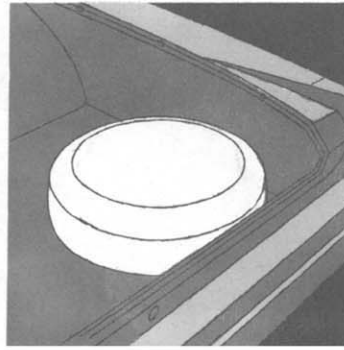

**SPARE TIRE COVER** . . . designed to slip over spare tire to help protect luggage and other items from becoming marred or damaged. Improves look of entire luggage compartment. (All models except Safari.) (FD)

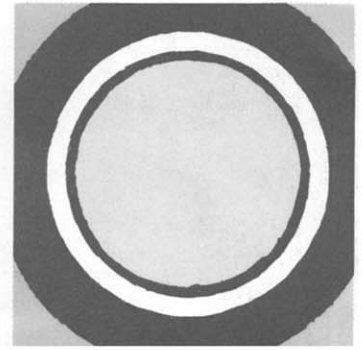

**WHITE SIDEWALL TIRES (Tubeless)** . . . for a smart glamour look. Available size 6.00 x 15 on Sedan, Coupe and Convertible, and 6.50 x 15 on Safari models. (6.50 x 15 optional on models except Safari.) (FD)

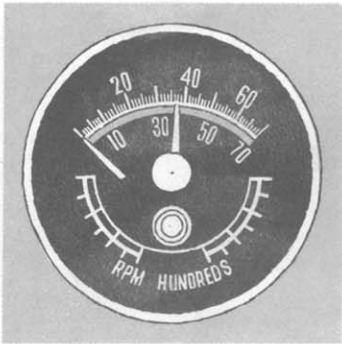

**TEMPEST TACHOMETER** . . . indicates exact number of engine RPM's for optimum driving performance. A "must" for the sports-minded driver. (FD)

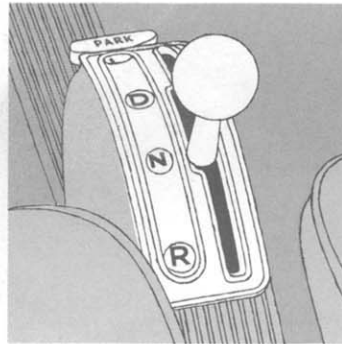

**TEMPEST CONSOLE** . . . available on Le Mans with automatic transmission. Sports-type, mounted on floor between front seats with a special transmission "PARK" lever. (F)

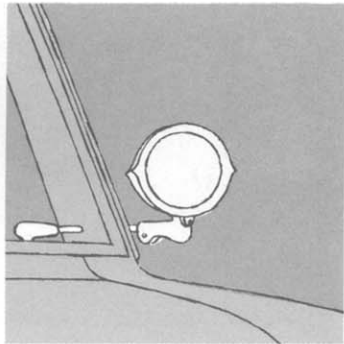

**TEMPEST SPOT LAMP** . . . easily controlled from inside the car by simply twisting the handle. Spot lamp is completely chromed for long wearing durability. Great for reading road signs, house numbers, etc. at night. (D)

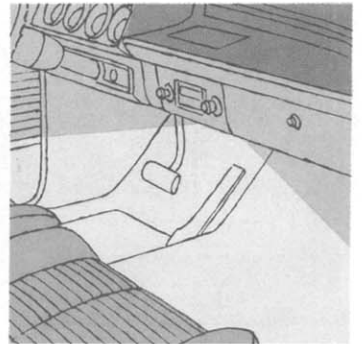

**COURTESY LAMP** . . . driver and passengers enter and leave car safely and conveniently at night . . . lamp flashes on when front door is opened. Can be operated manually by switch on instrument panel (FD)

**Pontiac Motor Division of General Motors Corporation reserves the right to make changes at any time, without notice, in colors, materials, equipment, specifications, prices and models, and also to discontinue models. The right is also reserved to change any specifications, parts, or equipment at any time without incurring any obligation to equip same on cars built prior to date of such change.**