

A close-up, black and white photograph of a BMW 7 Series. The image shows a portion of a multi-spoke alloy wheel on the left, with a tire tread visible. To the right, the sleek, curved side panel of the car is shown, featuring a prominent, sculpted air vent. The lighting is dramatic, highlighting the metallic textures and sharp lines of the vehicle's design.

A MASTER CLASS IN PERFECTION.

SEDAN

The BMW 7 Series offers an unparalleled driving experience with its state-of-the-art engineering, technology and luxury. The exterior, with its dynamic proportions, precise lines and sculpted surfaces, is an aesthetic marvel, radiating power and elegance. With its Carbon Core design, BMW's flagship sedan is stronger than steel, yet 50 percent lighter. Oh, and it's fast: with its 445-hp V-8 TwinPower Turbo engine, it roars from 0–60 in 4.3 seconds.¹

¹ BMW preliminary test results. BMW urges you to obey all posted speed laws and always wear safety belts.

BMW 7 SERIES

7



X Close

AESTHETIC EXCELLENCE.

Self-assured, authoritative and formidable. That pretty much sums up the front end of the BMW 7 Series, with its broad frame, large kidney grille and an air inlet extending along the entire front apron that enhances the distinctive appearance.

BMW 7 SERIES SEDAN

[EXTERIOR COLORS](#)

[UPHOLSTERY](#)

[INTERIOR TRIMS](#)

[WHEELS / TIRES](#)

[PACKAGES](#)

[TECHNICAL DATA](#)



BEAUTY REDEFINED.

No wonder the BMW 7 Series has such a unique presence. An eye-catching horizontal chrome bar in the rear boldly extends across the width of the car, creating an optical connection between the lights. Also striking are the tailpipe finishers surrounded by a chrome frame.



BEING IN CONTROL NEVER FELT SO GRAND.

Step into the cabin and you'll find yourself at the center of command, whether navigating the iDrive 5.0 system with Gesture Control, toggling entertainment features, or using the standard WiFi Hotspot* to stream content directly from your mobile device.

*Includes a 3 GB or 3-month trial, whichever ends first, under an AT&T contract.

7 SERIES SEDAN

EXTERIOR

NON-METALLIC

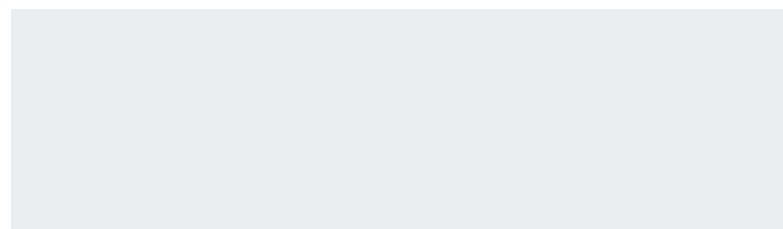

300 Alpine White (Non-metallic)

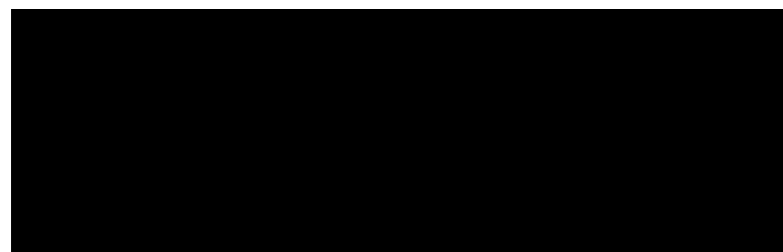

668 Jet Black (Non-metallic)

METALLIC

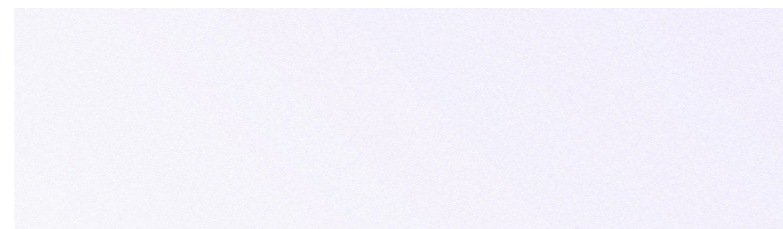

A96 Mineral White Metallic

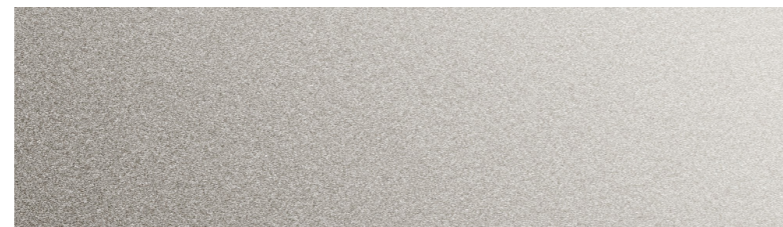

A72 Cashmere Silver Metallic



A83 Glacier Silver Metallic



A90 Dark Graphite Metallic



C27 Arctic Gray Metallic

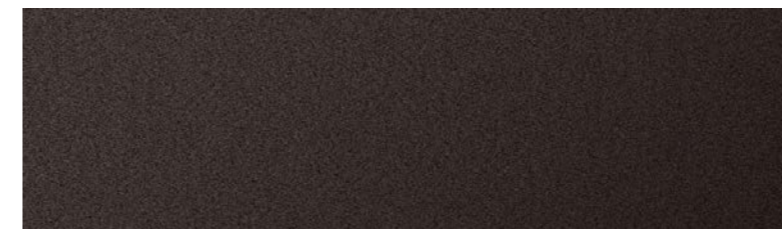

B65 Jatoba Brown Metallic

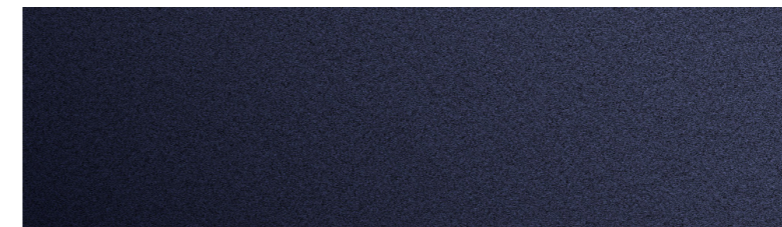

A89 Imperial Blue Metallic

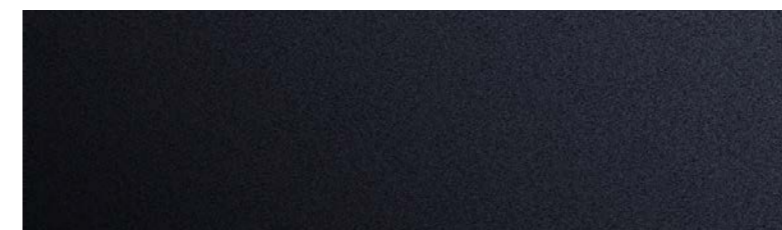

416 Carbon Black Metallic

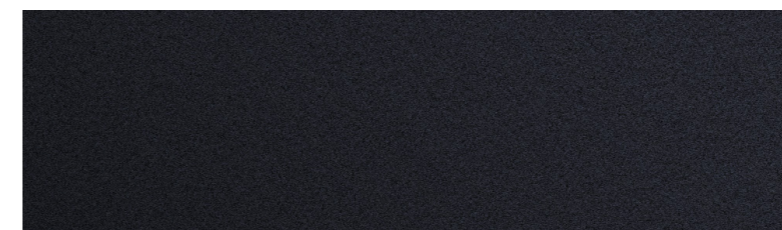

B41 Singapore Gray Metallic



C26 Magellan Gray Metallic

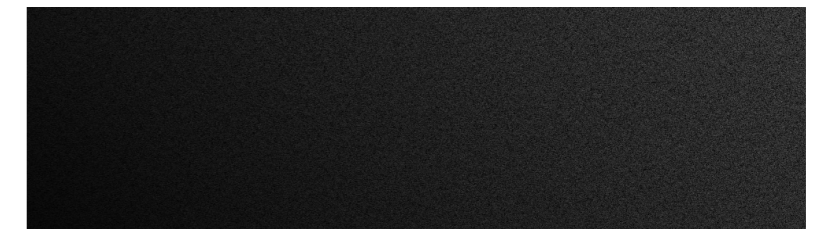

475 Black Sapphire Metallic

BMW INDIVIDUAL

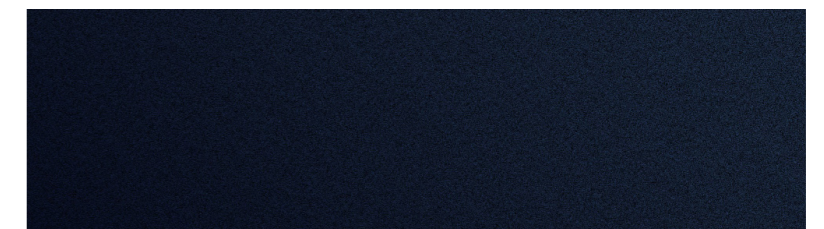

S34 Azurite Black Metallic

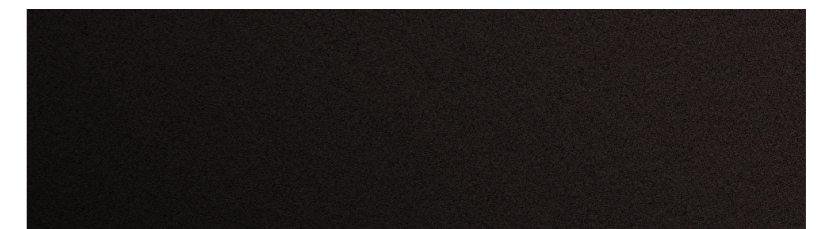

X03 Ruby Black Metallic

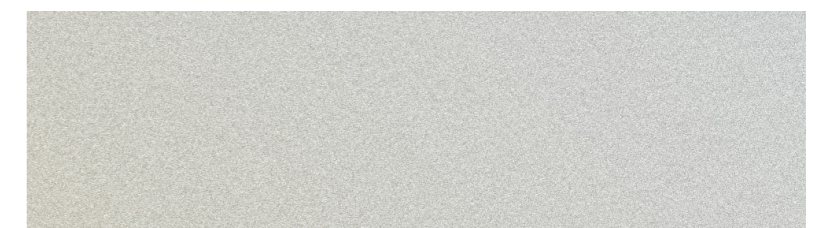

X04 Moonstone Metallic

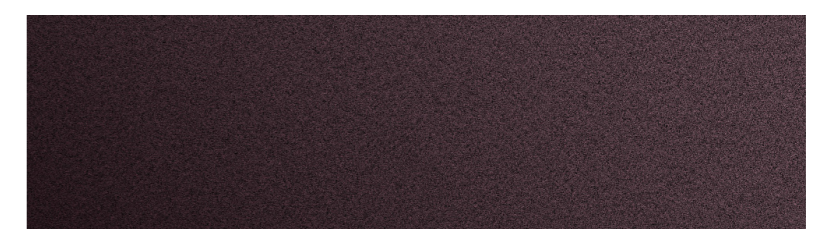

X14 Almandine Brown Metallic

7 SERIES SEDAN

UPHOLSTERY

DAKOTA LEATHER (Available on 40i)

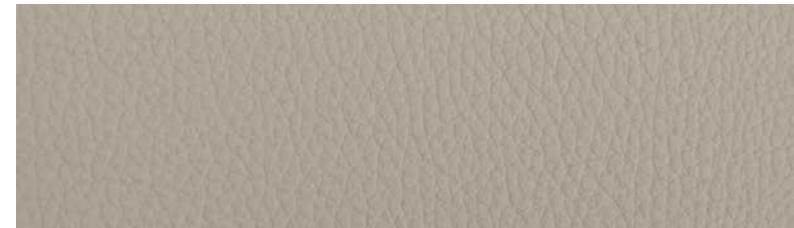

LCCY Canberra Beige Dakota Leather

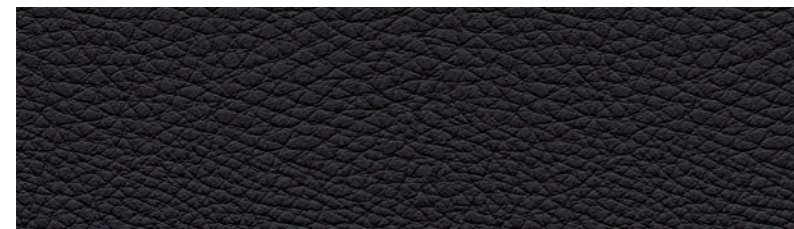

LCSW Black Dakota Leather

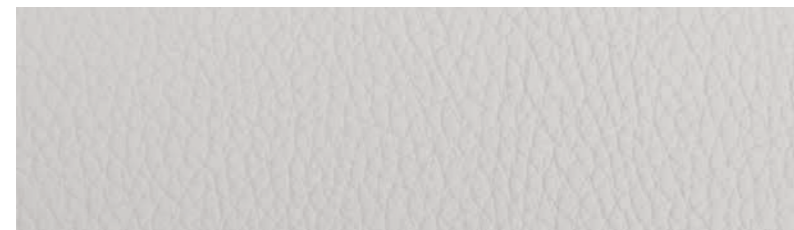

LCEW Ivory White / Black Dakota Leather



LCMY Mocha Dakota Leather

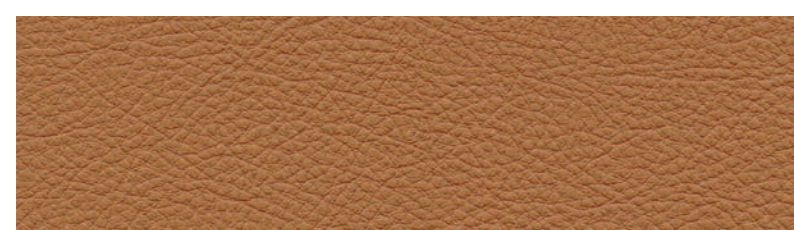

LCRI Cognac Dakota Leather

NAPPA LEATHER

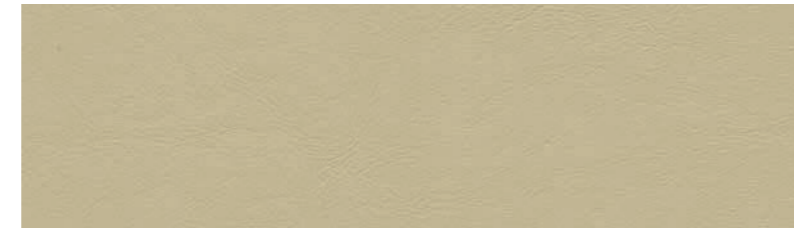

NACY Canberra Beige Nappa Leather

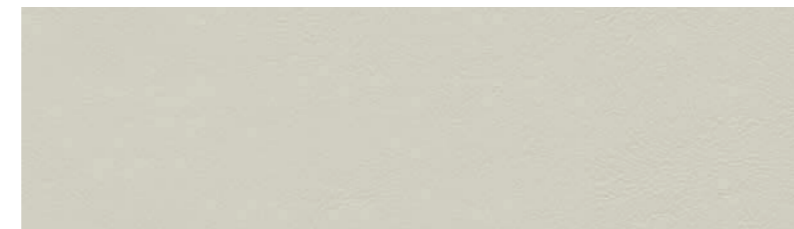

NAEW Ivory White / Black Nappa Leather

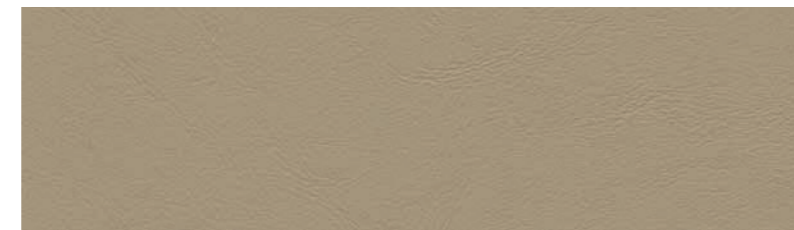

NAFZ Zagora Beige Nappa Leather



NAMY Mocha Nappa Leather



NARI Cognac Nappa Leather

NAPPA LEATHER (CONTINUED)

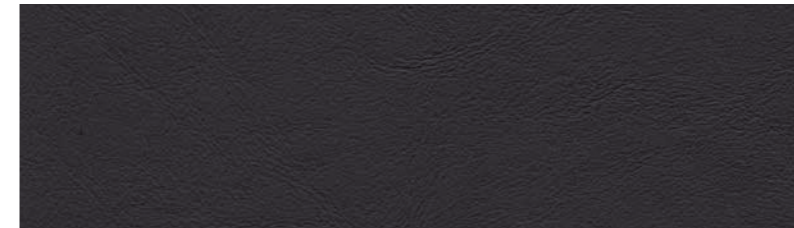

NASW Black Nappa Leather

BMW INDIVIDUAL



ZBCR Caramel / Black Full Merino Leather

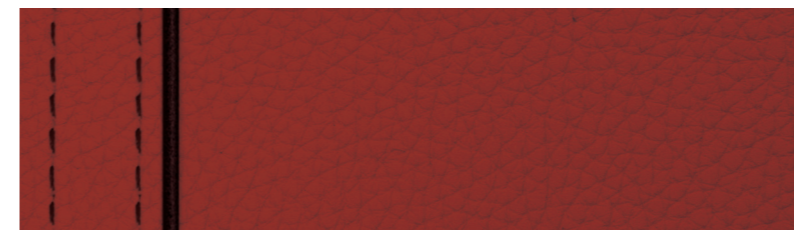

ZBFQ Fiona Red / Black Full Merino Leather



ZBFU Smoke White / Black Full Merino Leather



ZBKS Cashmere Beige / Black Full Merino Leather



ZBRJ Smoke White / Viola Full Merino Leather

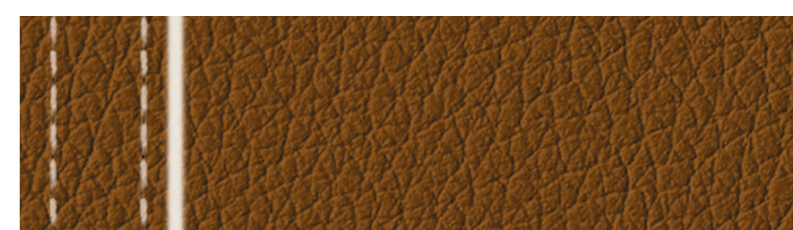

ZBTQ Tartufo Full Merino Leather

7 SERIES SEDAN

INTERIOR TRIMS

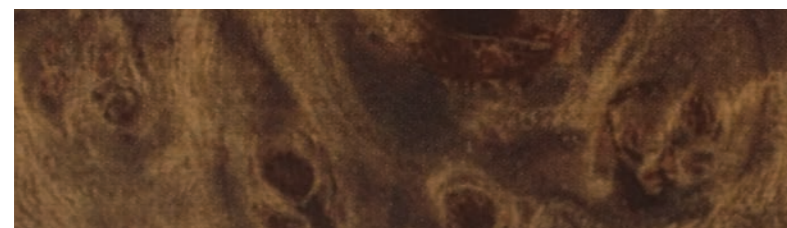

4BP Light Poplar Wood trim



4AX Chestnut Wood trim / wooden inlay

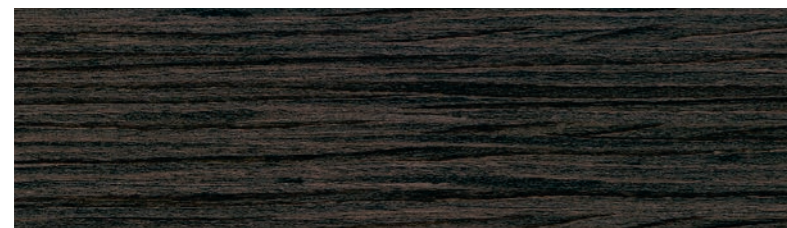

4LM Fineline Black Wood trim



4AS Gray Poplar Wood trim



4AY American Oak Wood trim / metal inlay

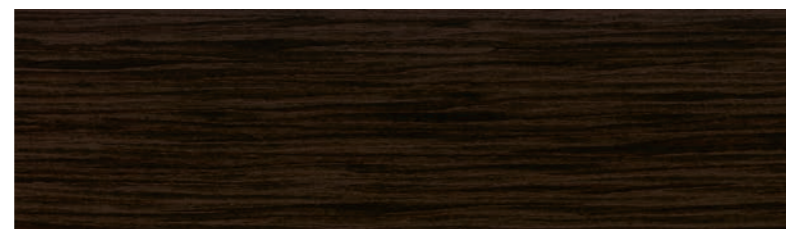

4B7 Fineline High-Gloss Wood trim

BMW INDIVIDUAL

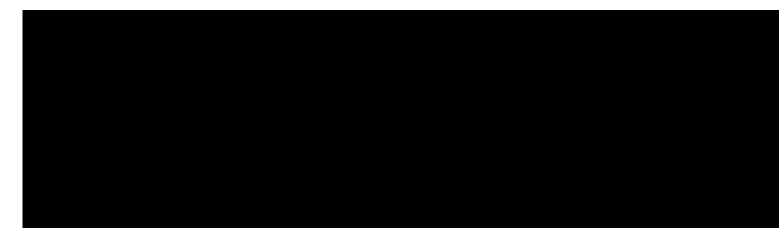

XE7 Piano Black trim

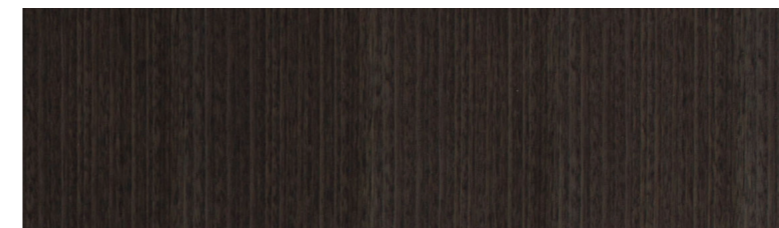

XEA Eucalyptus Smoke Brown Wood trim

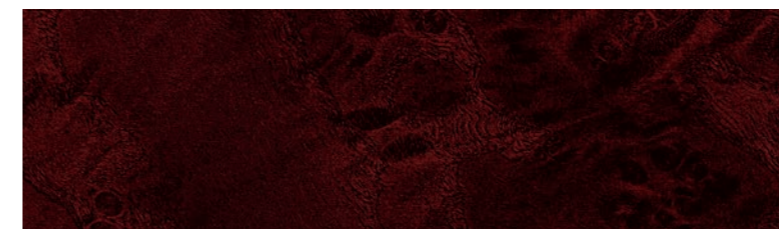

XEB Ash Grain Black / Red Wood trim

7 SERIES SEDAN

PACKAGES

AUTOBAHN PACKAGE

Integral Active Steering
Active Comfort Drive with Road Preview
Includes black painted brake calipers

INTERIOR DESIGN PACKAGE

Grab Handle in Wood trim
Rear safety-belt cover with Wood trim
Rear center armrest with Wood trim
Luxury rear floormats
Alcantara® headliner in coordinated upholstery color
(options available)

LUXURY REAR SEATING PACKAGE

Rear ventilated seats
Rear Comfort seats
Heated steering wheel with front and rear heated seats and armrests
Rear massaging seats
7" Touch Command tablet

BMW INDIVIDUAL COMPOSITION

Anthracite Alcantara® Headliner (options available)
Individual door-sill finishers
Azurite Black Metallic paint (options available)
Piano Black trim (options available)
BMW Individual Leather steering wheel with Fine Wood
Tartufo Full Merino Leather Upholstery (options available)

REAR EXECUTIVE LOUNGE SEATING PACKAGE

Electric reclining seat and footrest
Executive Lounge rear center console
Rear-seat Entertainment Professional with iDrive control
Executive Lounge Seating

M SPORT PACKAGE

19-inch Double-Spoke Bicolor wheels (Style 647M) (options available)
Fineline Black Wood trim (options available)
Aerodynamic kit
Shadowline exterior trim (options available)
Anthracite headliner (options available)
M door sills
M footrest

COLD WEATHER PACKAGE

Heated steering wheel
Front and rear heated seats

DRIVER ASSISTANCE PLUS II

Active Driving Assistant Plus
Active Lane Keeping Assistant with side collision avoidance
Traffic Jam Assistant

EXECUTIVE PACKAGE

Power rear sunshade and rear side-window sunshades
Front ventilated seats
Multi-contour seats
Instrument panel with Nappa Leather finish
Ceramic Controls
Head-up Display

DRIVER ASSISTANCE PLUS

Active Driving Assistant¹
Side- and Top-View Cameras
Parking Assistant
Active Blind Spot Detection
Daytime Pedestrian Protection
Frontal Collision Warning with City Collision Mitigation
Lane Departure Warning²
Speed Limit Info

¹Active Driving Assistant is not a substitute for the driver's own responsibility in maintaining safe control of the vehicle. Not all features are available on all models.

²Requires clearly definable lane markings that are not obscured by rain, snow, etc. Lane Departure Warning feature is not a substitute for the driver's own responsibility in maintaining safe control of the vehicle.

Get the latest information on standard and optional features, packages and technical specifications. Visit bmwusa.com and select the BMW model of your choice.

7 SERIES SEDAN

WHEELS / TIRES



V Spoke light alloy wheels (Style 642)
18 x 8.0 front and rear; and 245/50 front and rear run-flat all-season tires^{1,2}



Double Spoke light alloy wheels (Style 630)
19 x 8.5 front and rear; and 245/45 front and rear run-flat all-season tires^{1,2}



V Spoke light alloy wheels (Style 620)
19 x 8.5 front and rear; and 245/45 front and rear run-flat all-season tires^{1,2}



Double Spoke Bicolor light alloy wheels (Style 647M)
19 x 8.5 front and rear; and 245/45 front and rear run-flat all-season tires^{1,2}
19 x 8.5 front, 19 x 9.5 rear; and 245/45 front, 275/40 rear run-flat performance tires^{1,2,3}



Double Spoke Bicolor light alloy wheels (Style 648M)
20 x 8.5 front, 20x10.0 rear; and 245/40 front, 275/35 rear run-flat performance tires^{1,2,3}



V Spoke Bicolor light alloy wheels (Style 628)
20 x 8.5 front, 20x10.0 rear; and 245/40 front, 275/35 rear run-flat performance tires^{1,2,3}



Star Spoke Forged Polished light alloy wheels (Style 646)
20 x 8.5 front, 20x10.0 rear; and 245/40 front, 275/35 rear run-flat performance tires^{1,2,3}



V Spoke BMW Individual light alloy wheels (Style 649i)
20 x 8.5 front, 20x10.0 rear; and 245/40 front, 275/35 rear run-flat performance tires^{1,2,3}

¹ Does not come equipped with spare wheel and tire.

² Driving over rough or damaged road surfaces, as well as debris, curbs and other obstacles, can cause serious damage to wheels, tires and suspension parts. This is more likely to occur with low-profile tires, which provide less cushioning between the wheel and the road. Be careful to avoid road hazards and reduce your speed, especially if your vehicle is equipped with low-profile tires.

³ Performance tires include Mobility Kit; not recommended for driving in ice and snow conditions.

7 SERIES SEDAN

TECHNICAL DATA



	BMW 740i / 740i xDrive	BMW 750i / 750i xDrive	M760i xDrive
ENGINE	3.0-liter TwinPower Turbo inline 6-cylinder	4.4-liter TwinPower Turbo V-8	6.6-liter M Performance TwinPower Turbo V-12
OUTPUT @ RPM	320 hp @ 5500–6500 / 332 lb-ft @ 1380–5000	445 hp @ 5500–6000 / 479 lb-ft @ 1800–4500	600 hp @ 5500–6500 / 590 lb-ft @ 1550–5000
0–60 MPH (sec) ¹	5.4 / 5.1	4.6 / 4.3	3.6
CITY / HIGHWAY / COMBINED MPG	21/29/24 / 19/28/22	17/26/20 / 16/25/19	TBD

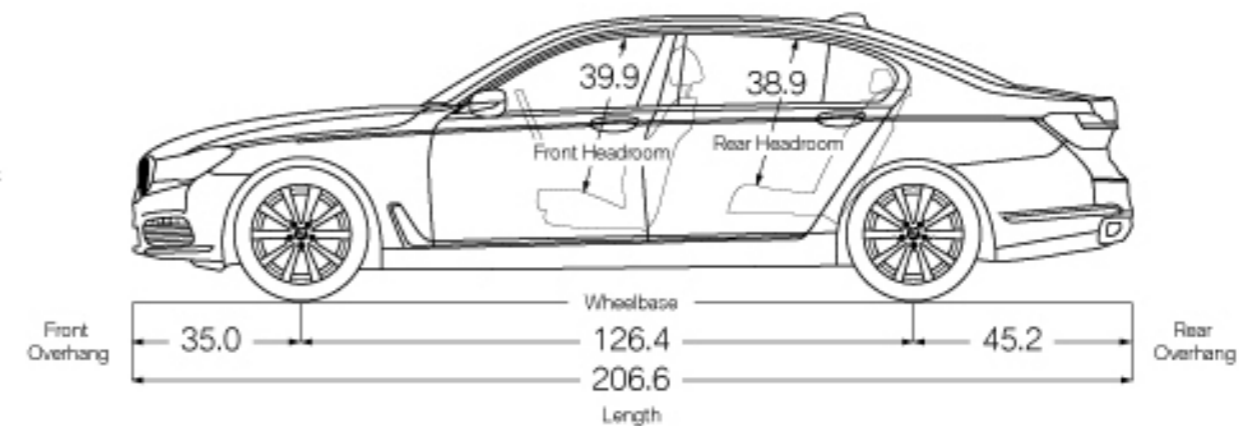
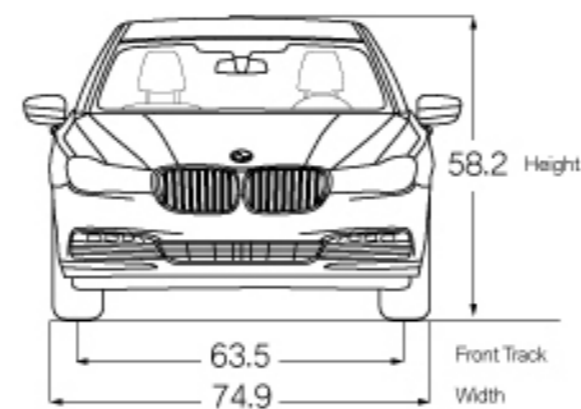

All dimensions in technical drawings are given in inches. Dimensions shown apply to 740i and 740i xDrive Sedan.

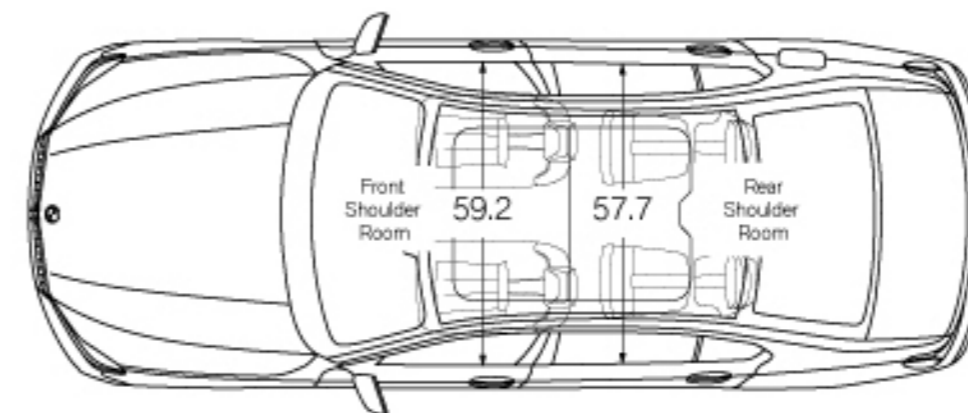
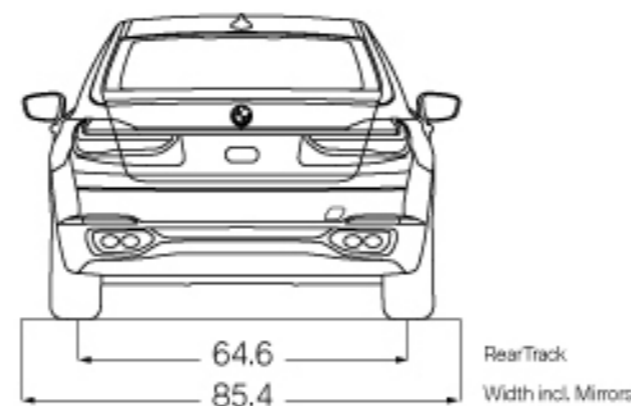

Figures subject to change. Not all packages available in all models. Please visit your BMW Retailer or bmwusa.com for the most up-to-date information.

¹BMW AG preliminary test results. Actual acceleration results may vary, depending on specification of vehicle; road and environmental conditions; testing procedures and driving style. These results should be used for comparison only and verification should not be attempted on public roads. BMW urges you to obey all posted speed laws and always wear safety belts.

Not all features are available on all models. Get the latest information on standard and optional features, packages and technical specifications. Visit bmwusa.com and select the BMW model of your choice.